

# Owner's Manual

For those who appreciate Quality, Reliability and Performance

**KIRBY®**

TM



# Congratulations

Congratulations.

Welcome to the Kirby® family! Your new G5™ was designed for individuals, like you, who appreciate quality, reliability and performance.

The G5 is the result of years of extensive research. Dedicated Kirby engineers employed the latest state-of-the-art technology and the highest quality materials to design and build this, the latest generation Kirby. All of which means you own one of the most complete, advanced and easy-to-use home maintenance systems available today.

To fully enjoy the benefits of your new Kirby Home Care System (“Kirby”), you will want to know the correct way to use its many features. This Owner’s Manual provides information you need to obtain the utmost in cleaning convenience. It will also help you provide the best care for your system. So please become familiar with the G5 by reading the entire Owner’s Manual.

In the event you require service or information about your Kirby G5, attachments, accessories or warranty, your authorized independent Kirby Distributor will be happy to provide assistance. Check your telephone Yellow Pages under the heading “Vacuum Cleaners” for the authorized Kirby Distributor near you.

Look for the Registered Kirby Trademark.

# Important Safety Instructions

The Kirby® G5™ Model G5D is Listed and Certified by Underwriters Laboratories Inc. and Canadian Standards Association as a double insulated appliance. The Model 293097 and 295097 Carpet Shampoo System, Model 293197 and 295197 Floor Care System, Model 293597 Zippbrush™ and Model 293297 Turbo Accessory System™ are also Listed and Certified as Optional Accessories for use with this G5 model. Outside North America, Kirby products are approved by national test authorities as appropriate.

***WHEN USING AN ELECTRICAL APPLIANCE, BASIC PRECAUTIONS SHOULD ALWAYS BE FOLLOWED. BE FAMILIAR WITH ALL THE IMPORTANT SAFETY INSTRUCTIONS BEFORE USING YOUR KIRBY.***

***WARNING - TO REDUCE THE RISK OF FIRE, ELECTRIC SHOCK OR INJURY:***

Do not leave appliance unattended or running when plugged in. Unplug from outlet when not in use and before servicing.

Do not use outdoors. Use only on dry surfaces or with the Kirby Carpet Shampoo System.

Do not allow to be used as a toy. Close attention is necessary when used by or near children. Do not let children use the cleaner unattended.

Use only as described in this manual. Use only manufacturer's recommended attachments.

Do not use with damaged cord or plug. If appliance is not working as it should, has been dropped, damaged, left outdoors or dropped into water, return it to a service center.

Do not pull or carry by cord, use cord as a handle, close door on cord, or pull cord around sharp edges or corners. Do not run appliance over cord. Keep cord away from heated surfaces.

Do not unplug by pulling on cord. To unplug, grasp the plug, not the cord.

Do not handle plug or appliance with wet hands.

Do not put any object into openings. Do not use with any opening blocked; keep openings free of dust, lint, hair and anything that may reduce airflow.

Keep hair, loose clothing, fingers and all parts of body away from openings and moving parts.

Do not pick up anything that is burning or smoking, such as cigarettes, matches or hot ashes.

Do not use without dustbag and/or filters in place.

Turn Kirby OFF before unplugging the cord.

Use extra care when cleaning on stairs.

Do not use to pick up flammable or combustible liquids, such as gasoline or use in confined areas where flammable or combustible vapors are present.

When using the Carpet Shampoo System, do not use flammable or combustible liquids to clean carpet or floor.

When using the Floor Care System, use only genuine Kirby cleaning products or commercially available floor cleaners or waxes intended for machine operation.

Unplug the cord from the wall outlet and let the motor come to a complete stop before attempting any cleaning, service or changing accessories.

This appliance is provided with Double Insulation. It should be serviced by a qualified Kirby service person using genuine Kirby parts to maintain safety and to protect your warranty. See page 51.

Keep all Kirby chemicals out of the reach of children. These chemicals may cause irritation or discomfort if swallowed or placed in the eyes.

Do not use flammable or combustible fluid in the Portable Sprayer.

Do not use pesticides or chemical products in the Portable Sprayer that may affect or damage the human respiratory system, eyes or skin.

***SAVE THESE INSTRUCTIONS  
FOR HOUSEHOLD USE ONLY***

# Table of Contents

<b>Important Safety Instructions</b>	<b>2</b>
<b>About this Manual</b>	<b>4</b>
<b>Part 1—Getting Started</b>	<b>5</b>
Moving Your G5™/Handle Tilt Latch/Toe-Touch Control™	6
Power Nozzle Height Adjustment/TechDrive® Power Assist	7
Installing/Changing Disposable Filter Bags	8
Bag Support Strap/Mini Em-Tor®	9
The Belt Lifter	9
<b>Part 2—Upright &amp; Portable Cleaner</b>	<b>11</b>
The Upright Cleaner	12
The Upright as a Straight Suction Cleaner	13
The Portable Cleaner	14
<b>Part 3—Canister Cleaner &amp; Attachments</b>	<b>17</b>
Installing the Attachment Hose	18
Extension Tubes/Surface Nozzle	19
Duster Brush/Upholstery Nozzle	20
Crevice Tool/Wall & Ceiling Brush	20
Massage Cup/Suction Control Grip	21
Using Your G5 as a Blower	21
The Portable Sprayer	24
The Portable Shampooer™	26
<b>Part 4—Optional Accessories</b>	<b>29</b>
The Carpet Shampoo System	30
The Miracle Waxer™	36
The Floor Care System - Floor Buffer	37
The Floor Care System - Carpet Fluffer	40
The Turbo Accessory System™	41
The Zippbrush™	43
<b>Part 5—Operating/Maintenance Tips</b>	<b>45</b>
Changing the Power Nozzle Belt	46
Adjusting the Brush Roll Height	48
Light Bulb Replacement	49
Miscellaneous Parts Replacement	50
Questions and Answers/Troubleshooting	51
Other Fine Kirby® Cleaning Products	54
<b>Index</b>	<b>56</b>
Expanded Illustration of G5 and Filtration System - Inside back cover.	

# About This Manual

## Using this Owner's Manual

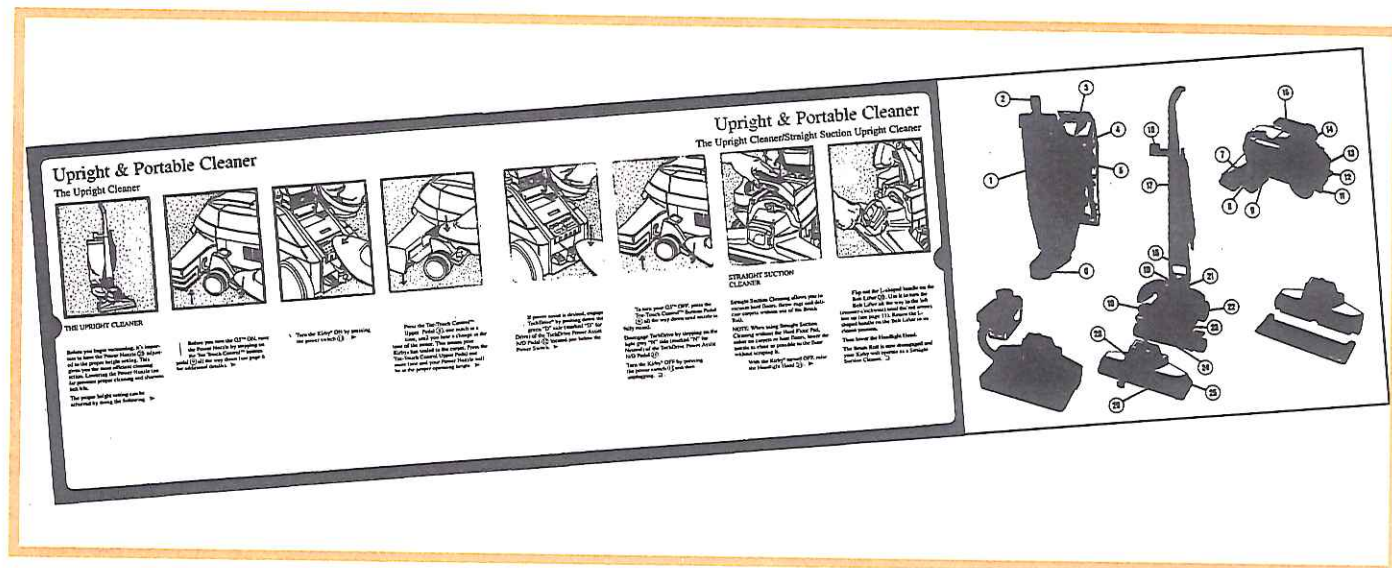

This Owner's Manual was designed to be easy to read and follow. It has been organized in sections based on the various ways you may use your new G5™. Within each section, simple step-by-step illustrations will help you easily visualize the steps required to properly operate your new Kirby® and its many attachments and optional accessories.

Please note: The rear cover of this Owner's Manual includes a fold-out illustration that points out the location of various parts of your new G5. Simply fold this flap out and refer to the illustrations and corresponding (#) as you read this manual.

In addition to the Table of Contents on page 3, you will also find an Index on page 56 that will refer you to the information you require.

We at Kirby sincerely hope this Owner's Manual will help you obtain years of satisfactory performance from your world-class G5.

# Getting Started

## PART ONE

This section outlines general information you will need as you begin using your new G5™. It includes information on:

**Moving and Carrying Your G5™**

**Using the Handle Tilt Latch**

**The Toe-Touch Control™**

**Proper Power Nozzle Height**

**Using TechDrive® Power Assist**

**Installing/Changing Disposable Filter Bags**

**Emptying the Mini Em-Tor®**

**Understanding the Belt Lifter**

Please read this section (as well as all other sections) carefully before using your new G5.

# Getting Started

## Moving/Carrying Your G5™/Handle Tilt Latch and Toe-Touch Control™

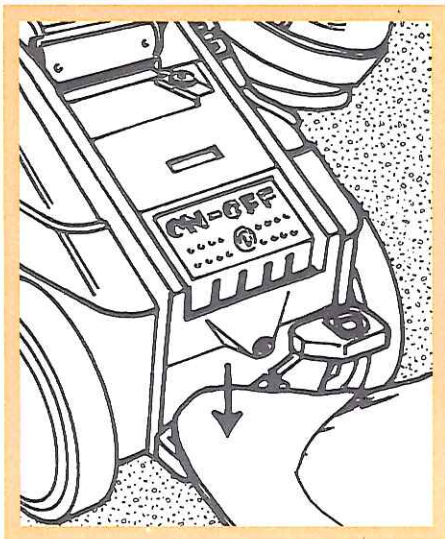

### MOVING YOUR G5™

Your G5 is equipped with TechDrive® Power Assist. In order to push your G5 with the motor OFF, TechDrive Pedal (11) must be turned OFF (disengaged).

Turn TechDrive OFF by pushing down on the light gray "N" side (marked "N" for Neutral) of the TechDrive Power Assist N/D Pedal. (See page 8 for additional information.)

### CARRYING YOUR G5™

NOTE: The Carrying Grip (18) is designed for convenience in carrying your G5. □

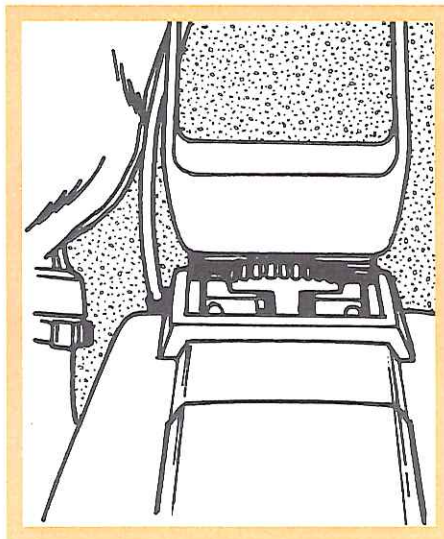

### HANDLE TILT LATCH

The Handle Tilt Latch (10) serves two purposes:

1 To allow you to lift the front of the Kirby® over door thresholds or throw rugs. To do so, move the Tilt Latch Lever towards the bag. By doing this, the handle will only lower part way to the 45° position. This allows you to push down on the locked handle and lift the front of the Kirby. ➤

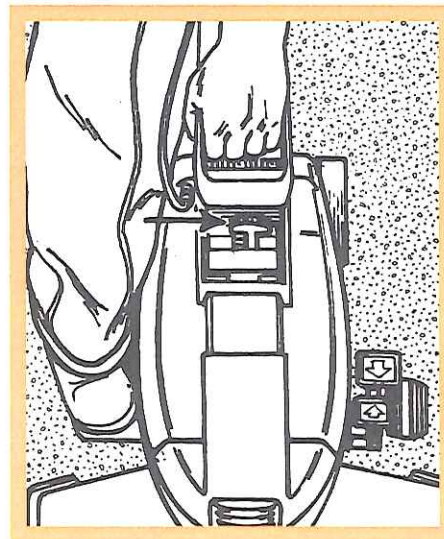

2 To allow you to store your Kirby in a vertical position or carry it.

To do this, lower the handle to a horizontal position near the floor. While pushing the handle down, move the Tilt Latch Lever away from the bag to lock the handle down. You can now stand the Kirby up onto its bumper and lean it against a wall for storage.

This vertical position may also be useful in carrying the Kirby. To lift the Kirby, use the Carrying Grip (18). □

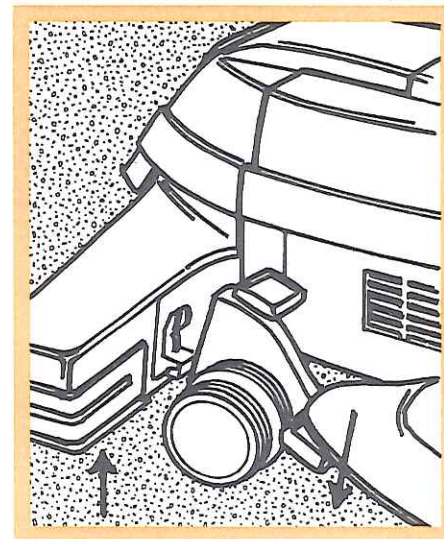

### THE TOE-TOUCH CONTROL™

The Toe-Touch Control (8), (9), located over the front wheel, raises and lowers the front of your Kirby.

Step down on the Toe-Touch Control Bottom Pedal (9) to raise the front (see page 12). ➤

#### ⚠ CAUTION:

Never unlock the Handle Tilt Latch without holding on to the handle. The handle is spring-loaded and could fly up when unlatched.



# Getting Started

## Power Nozzle Height Adjustment and TechDrive® Power Assist

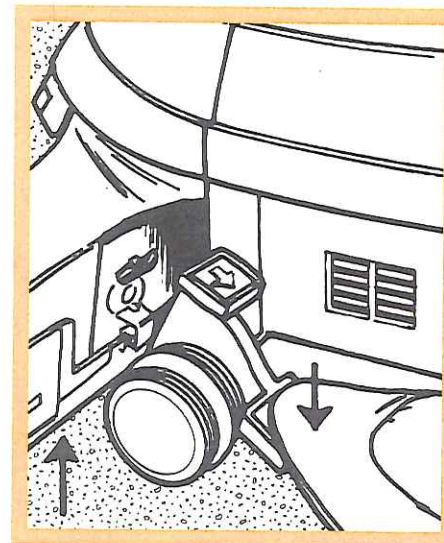
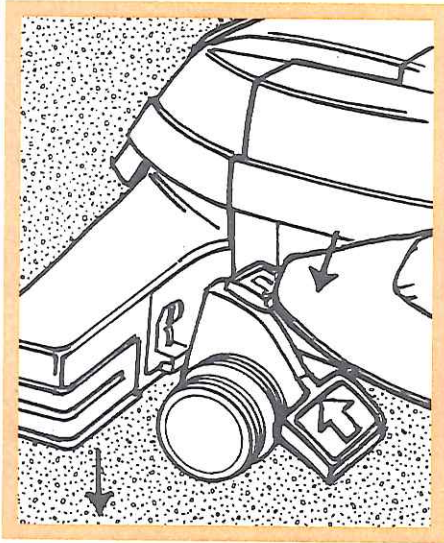

### POWER NOZZLE HEIGHT ADJUSTMENT

Then, each time you press on the Toe-Touch Control™ Upper Pedal (8), you will lower the front one notch.

The number of bars showing above the Toe-Touch Control provide an indication of height. □

When using the Power Nozzle (25), it is important to adjust the height properly. Start by pressing the Toe-Touch Control Bottom Pedal (9) all the way down, raising the front of your Kirby® all the way up.

Then, with your Kirby ON, press the Toe-Touch Control Upper Pedal (8), one notch at a time, until you hear a change in the tone of the motor. This means your Kirby has sealed to the carpet. Press the Toe-Touch Control Upper Pedal one more time and your Power Nozzle will be at the proper operating height.

NOTE: When finished vacuuming, press the Toe-Touch Control Bottom Pedal all the way down to move your Kirby. □

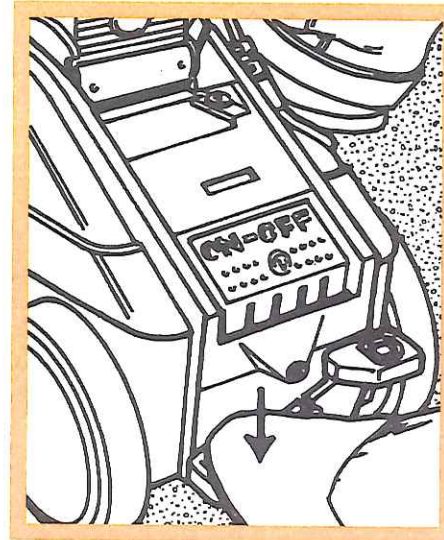

### TECHDRIVE®

Your new G5™ is equipped with TechDrive Power Assist. This innovative power assist feature eliminates most of the effort required to move your Kirby back and forth. □

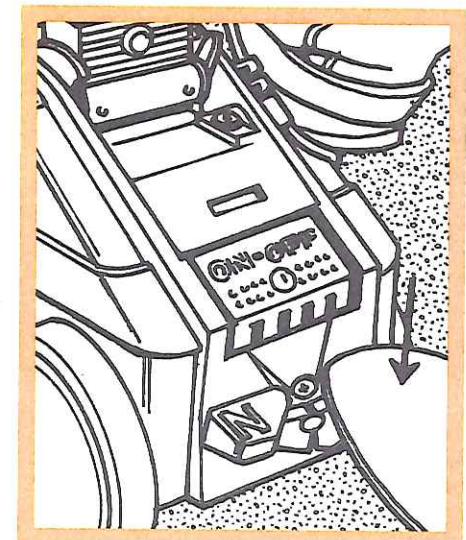

### TURNING TECHDRIVE® ON (DRIVE)

To engage TechDrive and put the Kirby in the Power Assist mode, push down the green "D" side (marked "D" for Drive) of the TechDrive N/D Pedal (12) located just below the Power Switch. (13)

You may use your G5 without TechDrive Power Assist if desired. Simply put TechDrive in Neutral (see next paragraph). □

### CAUTION:

To avoid possible damage to soft tiles or marking of waxed and finished non-carpeted floors, disengage the TechDrive.

# Getting Started

## TechDrive® Power Assist/Installing/Changing Disposable Filter Bags

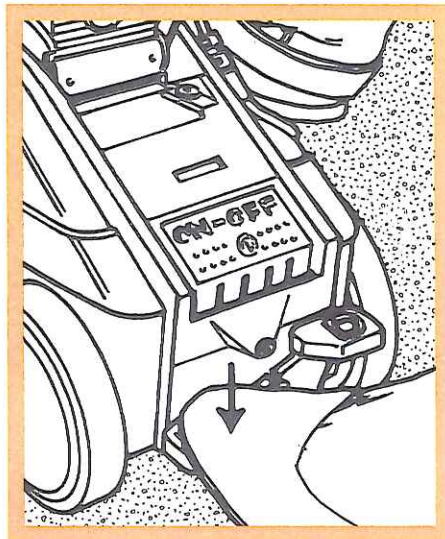

### TURNING TECHDRIVE® OFF (NEUTRAL)

To move your Kirby® with the motor OFF or to vacuum without Power Assist, TechDrive must be put in Neutral.

To place TechDrive in Neutral, push down the light gray "N" side (marked "N" for Neutral) of the TechDrive Power Assist N/D Pedal ⑪. ◻

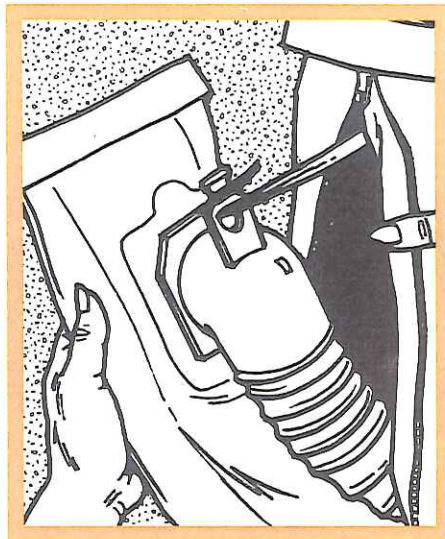

### INSTALLING/CHANGING DISPOSABLE FILTER BAGS

A Disposable Filter Bag must be installed before you begin vacuuming.

**1** To install a new Disposable Filter Bag, unzip the Outer Permanent Bag ① and pull out the Disposable Filter Bag along with the Top Adapter ⑤. ➤



**2** When necessary, remove the used Disposable Filter Bag.

**NOTE:** Always replace the Disposable Filter Bag when dirt reaches the "FULL" line on the bag. Failure to do so will affect performance.

From the rear of the Disposable Bag, grasp the cardboard faceplate. Holding the Top Adapter steady, rotate the cardboard faceplate to the left (counter-clockwise). When the lock tabs on the Top Adapter align with the slots in the cardboard faceplate, gently pull the bag off. ➤



**3** To install a new Disposable Filter Bag, grasp the cardboard faceplate from the rear of the Disposable Filter bag. Align the slots in the cardboard faceplate on the Disposable Filter Bag with the lock tabs on the Top Adapter. Then push the Top Adapter into the bag opening.

Holding the Top Adapter steady, rotate the cardboard faceplate to the right (clockwise) to secure the Disposable Filter Bag.

**NOTE:** To avoid air leaks, make sure the cardboard faceplate is securely positioned up against the flat portion of the Top Adapter. ➤



**CAUTION:**

Before changing the Disposable Filter Bag, unplug the power cord from the wall outlet and be sure that the motor and fan have stopped.

# Getting Started

## Bag Support Strap/Mini Em-Tor® and Belt Lifter

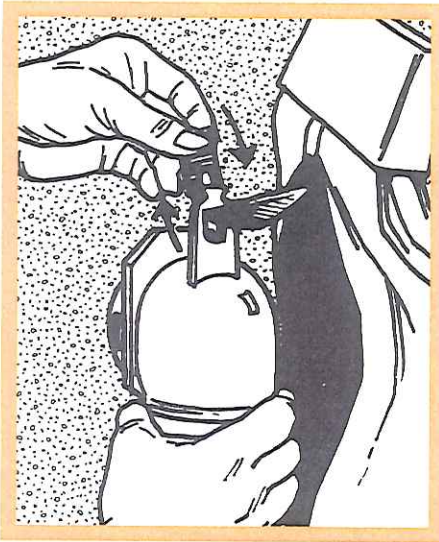

### BAG SUPPORT STRAP

**4** Check to make sure the Bag Support Strap (4) is connected to the Top Adapter (5). The Bag Support Strap provides the support required for proper operation of the Disposable Filter Bag.

If it is not connected, thread the strap through the small hole of the Top Adapter. Then place the hole in the strap over the stud on the Top Adapter.

Finally, insert the adapter and new filter bag into the Outer Permanent Bag (1) and close the zipper completely for maximum performance.

**NOTE:** In order for the Filtration System to perform effectively, use only Kirby® Micron Magic® Filtration Bags. If the outside bag is torn or damaged, please replace immediately. □



### EMPTYING THE MINI EM-TOR®

The Mini Em-Tor (6) is designed to collect large, heavy particles which can be emptied by removing the Mini Em-Tor.

**1** To remove, grasp the Mini Em-Tor in the handhold provided and rotate it away from the body of the Kirby as far as it will go, then lift it off.

The top of the bag is released from the handle by pressing the Bag Release Button (16). After removing the Mini Em-Tor and the entire Bag Assembly, position the front opening of the Mini Em-Tor over a newspaper and shake it to remove the particles. ➤



**2** To replace the Mini Em-Tor, reattach the entire Bag Assembly by inserting the Bag Latch Tab (2) at the top of the bag into the slot under the Bag Release Button (16).

Finally, line up the raised indicator arrow of the Mini Em-Tor with the indicator arrow on the Air Exhaust Port (19). Rotate the Mini Em-Tor towards the Kirby and lock it in place.

**NOTE:** The Mini Em-Tor must be securely locked in place or the Kirby will not operate. □

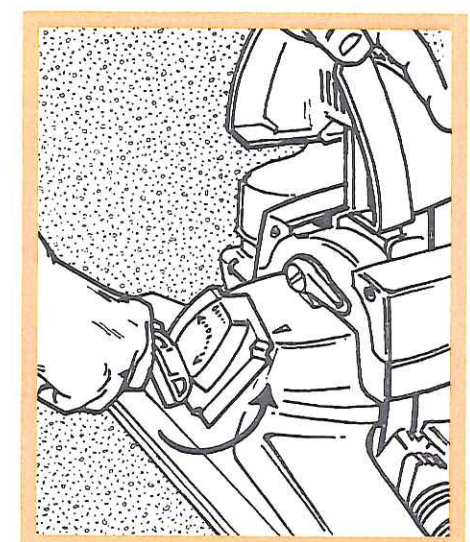

### USING THE BELT LIFTER

The Belt Lifter (20) on your G5™ is used for two purposes:

- 1) To engage or disengage the Brush Roll. When the Brush Roll is disengaged, the Kirby can be used as a straight suction cleaner (page 13), and;
- 2) To allow removal of the Power Nozzle when converting your Kirby for use with various attachments and optional accessories.

To avoid damaging the belt, turn the Kirby OFF before using the Belt Lifter. ➤

#### CAUTION:

Do not intentionally pick up heavy objects, such as coins, screws, rocks or similar objects. This may damage the fan.

# Getting Started

## The Belt Lifter (continued)

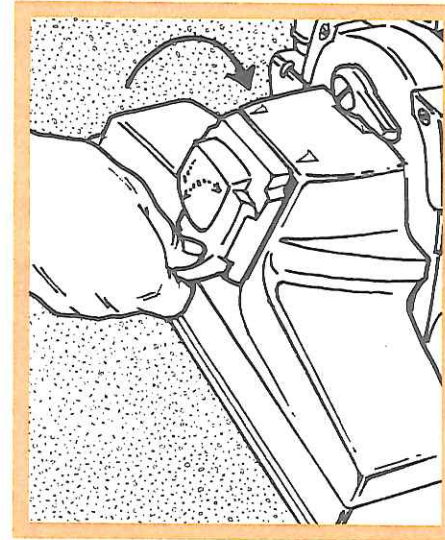
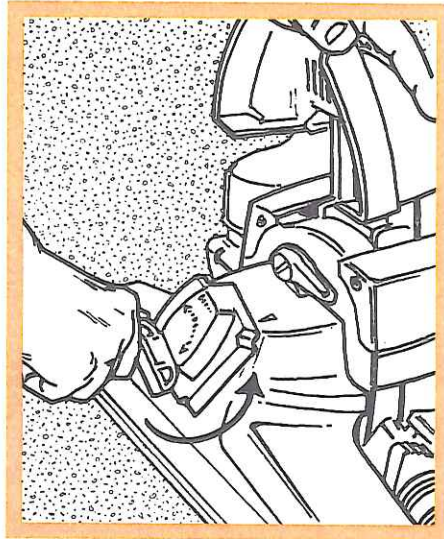
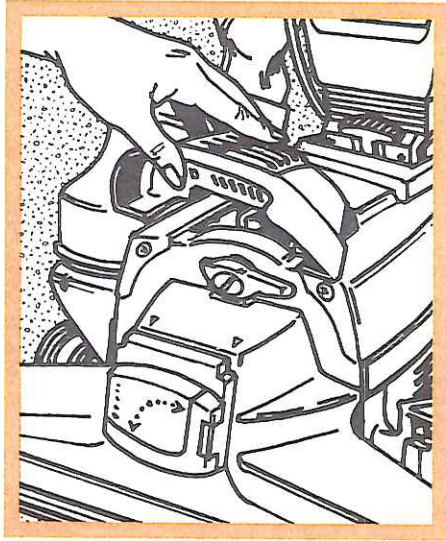

### USING THE BELT LIFTER (cont)

**1** To use the Belt Lifter, you must first raise the Headlight Hood (21). ➤

**2** Flip out the L-shaped handle on the Belt Lifter (20). Use it to turn the Belt Lifter fully to the left (counter-clockwise) until it stops and the red arrows line up. This stretches the belt and lifts it off the motor shaft. Return the L-shaped handle on the Belt Lifter to its closed position.

If you are using your Kirby® as a straight suction cleaner, simply lower the Headlight Hood. The Brush Roll is now disengaged and will not rotate when the power switch is turned ON. ➤

**3** To re-engage the belt so the Brush Roll rotates, simply raise the Headlight Hood and use the L-shaped handle to turn the Belt Lifter fully to the right (clockwise) until the green arrows line up. Then lower the Headlight Hood.

The Brush Roll will now rotate when the Power Switch is turned ON.

NOTE: The belt should not be stretched when stored for an extended period. Make sure the green arrows line up for storage. □

# Upright & Portable Cleaner

## PART TWO

Your Kirby® G5™ is an extremely versatile home maintenance system. In this section, we will discuss the following:

**Using your G5™ as an Upright Cleaner**

**Using your Upright as a Straight Suction Cleaner**

**Cleaning Hard-Surface Floors**

**Using your G5™ as a Portable Cleaner**

**Cleaning Mattresses and Carpeted Stairs**

This section provides the information you need to use your G5 for a wide variety of jobs.

# Upright & Portable Cleaner

## The Upright Cleaner

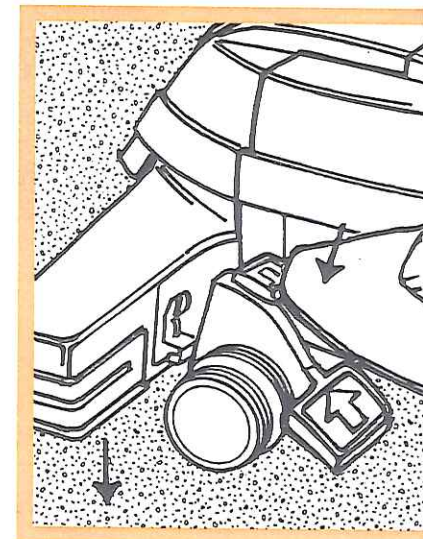
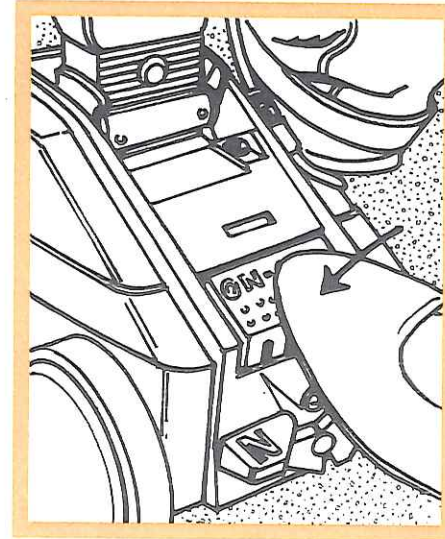
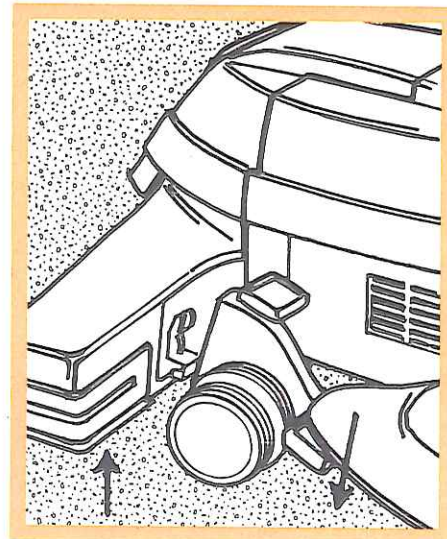
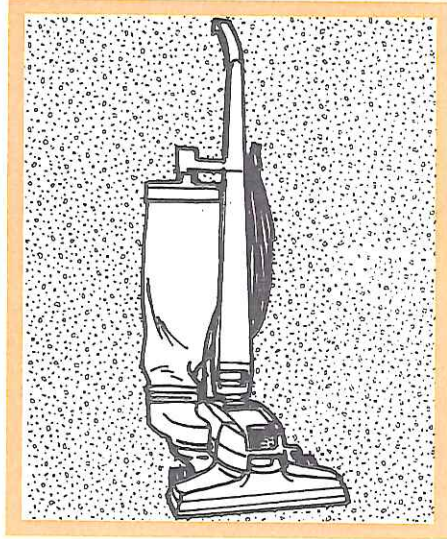

### THE UPRIGHT CLEANER

Before you begin vacuuming, it's important to have the Power Nozzle (25) adjusted to the proper height setting. This gives you the most efficient cleaning action. Lowering the Power Nozzle too far prevents proper cleaning and shortens belt life.

The proper height setting can be achieved by doing the following: ➤

**1** Before you turn the G5™ ON, raise the Power Nozzle by stepping on the Toe Touch Control™ Bottom Pedal (9) all the way down (see page 6 for additional details). ➤

**2** Turn the Kirby® ON by pressing the Power Switch (13). ➤

**3** Press the Toe-Touch Control™ Upper Pedal (8), one notch at a time, until you hear a change in tone of the motor. This means your Kirby has sealed to the carpet. Press the Toe-Touch Control Upper Pedal one more time and your Power Nozzle will be at the proper operating height. ➤

# Upright & Portable Cleaner

## The Upright Cleaner/Straight Suction Upright Cleaner

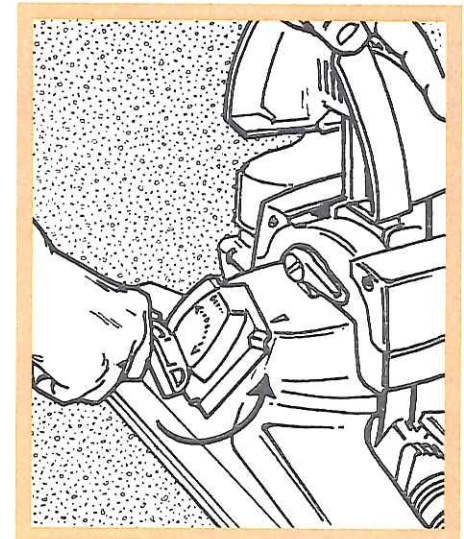
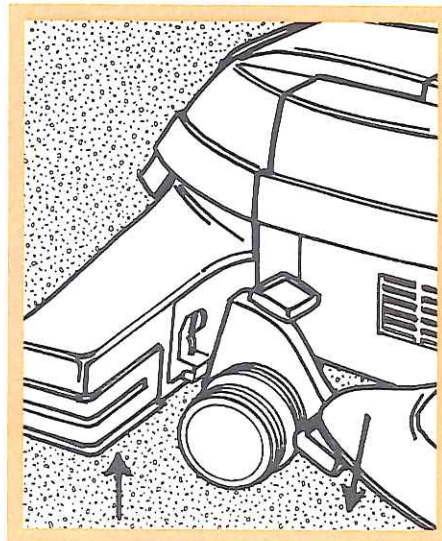
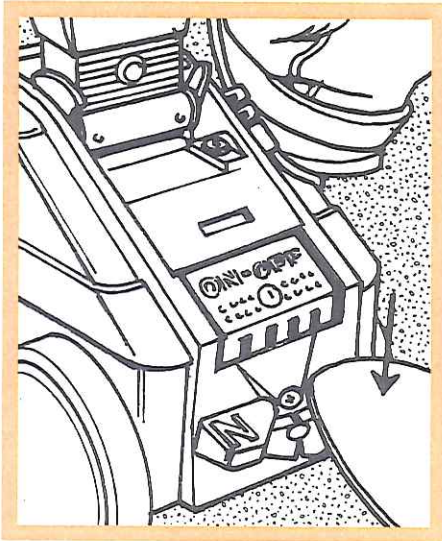

**4** If power assist is desired, engage TechDrive® by pushing down the green “D” side (marked “D” for Drive) of the TechDrive Power Assist N/D Pedal (12) located just below the Power Switch. (13) ➤

**5** To turn your G5™ OFF, press the Toe-Touch Control™ Bottom Pedal (9) all the way down until nozzle is fully raised.

Disengage TechDrive by stepping on the light gray “N” side (marked “N” for Neutral) of the TechDrive Power Assist N/D Pedal (11).

Turn the Kirby® OFF by pressing the Power Switch (13) and then unplugging. □

### STRAIGHT SUCTION CLEANER

Straight Suction Cleaning allows you to vacuum hard floors, throw rugs and delicate carpets without use of the Brush Roll.

NOTE: When using Straight Suction Cleaning without the Hard Floor Pad, either on carpets or bare floors, lower the nozzle as close as possible to the floor without scraping it.

**1** With the Kirby® turned OFF, raise the Headlight Hood (21). ➤

**2** Flip out the L-shaped handle on the Belt Lifter (20). Use it to turn the Belt Lifter all the way to the left (counter-clockwise) until the red arrows line up (see page 10). Return the L-shaped handle on the Belt Lifter to its closed position.

Then lower the Headlight Hood.

The Brush Roll is now disengaged and your Kirby will operate as a Straight Suction Cleaner. □

# Upright & Portable Cleaner

## The Hard Floor Pad and The Portable Cleaner

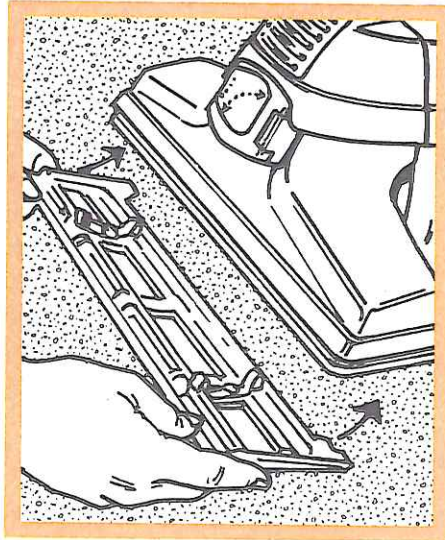

THE HARD FLOOR PAD

By attaching the optional Hard Floor Pad to your Kirby®, you may dust bare floors. While the Kirby is turned OFF, raise the Power Nozzle (25) as far as it will go by pressing the Toe-Touch Control™ Bottom Pedal (9). Attach the Hard Floor Pad onto the nozzle opening using the spring clips on the plate. Then lower the Power Nozzle by pressing the Toe-Touch Control Upper Pedal (8) one notch at a time until the bristles touch the floor.

NOTE: The Hard Floor Pad should only be used when the Kirby is in the Straight Suction Cleaner mode. When using the Hard Floor Pad, lower the nozzle until the bristles touch the bare floor. □

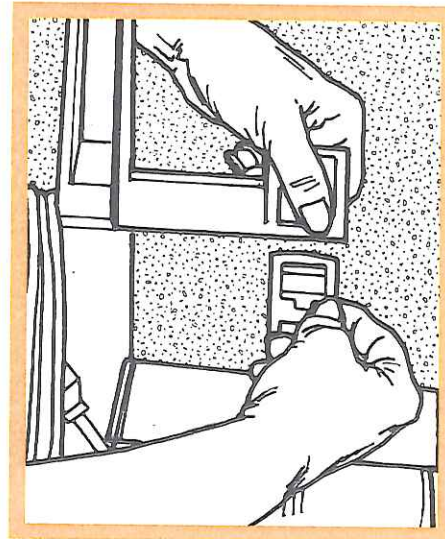

PORTABLE CLEANER SET-UP

Besides being a remarkable Upright Cleaner, the G5™ can easily be converted into a portable cleaner for mattresses and carpeted stairs.

**1** To convert your G5 to a Portable Cleaner, make sure the Kirby is turned OFF and unplugged.

Then release the Outer Permanent Bag Top from the Bag Support (16) by pressing the Bag Release Button (16) and sliding the bag top off. ➤

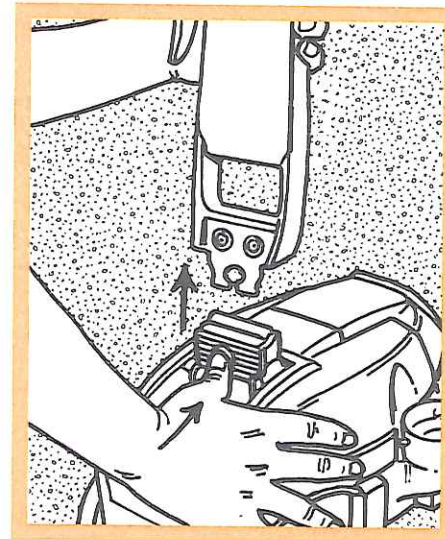

**2** Remove the cord from the handle. With the Upright Handle (17) in the vertical position, push the Handle Release Button (14), located at the base of the handle, and pull the handle straight up and out of the slot. (Bag not shown for clarity.) ➤

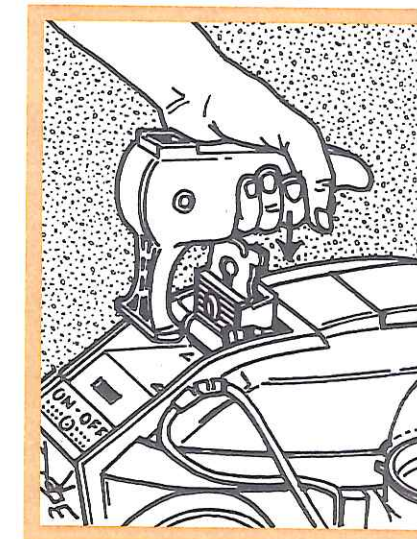

**3** Insert the Portable Handle (15) in the slot where the Upright Handle was connected. Push the Portable Handle into the slot until it snaps into place. ➤

**⚠ CAUTION:**

Before installing the Hard Floor Pad, turn unit OFF, unplug the power cord from the wall outlet and be sure the motor and nozzle brush have stopped.



# Upright & Portable Cleaner

## The Portable Cleaner

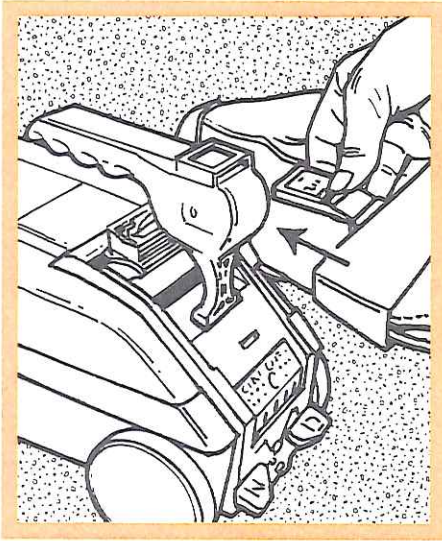

PORTABLE CLEANER SET-UP  
(cont)

**4** Bend the Filtration Bag Assembly ① in half and insert the Bag Latch Tab ② into the slot on the Portable Handle until it snaps into place. You are now ready for portable power cleaning. □

**⚠ CAUTION:** To reduce risk of injury in the portable mode, keep hair and loose clothing away from the Kirby while in operation.

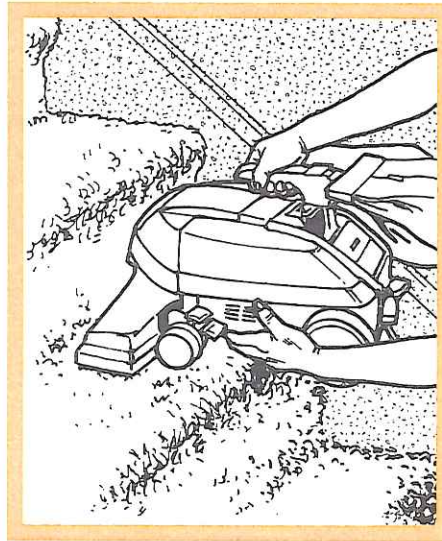

CARPETED STAIRS

Place your Kirby® on one of the carpeted steps, while supporting the rear of the Kirby. Using your hand, press the Toe-Touch Control™ Bottom Pedal ⑨ all the way down, raising the front of your Kirby all the way up.

Then, with your Kirby ON, press the Toe-Touch Control Upper Pedal ⑧, one notch at a time, until you hear a change in the tone of the motor. This means your Kirby has sealed to the carpet. Press the Toe-Touch Control Upper Pedal one more time and your power nozzle will be at the proper operating height.

Roll the cleaner back and forth so that the Brush Roll agitates the carpeting and loosens the dirt. □

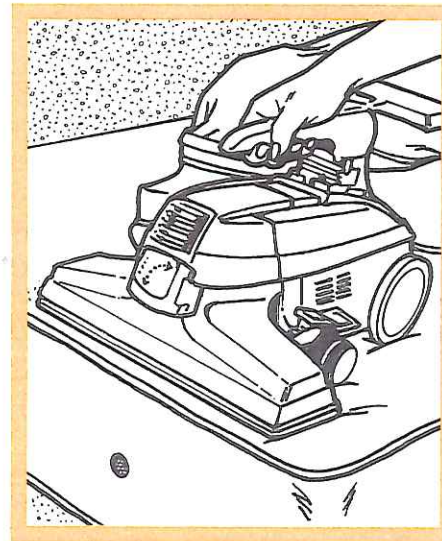

MATTRESS CLEANING

Cleaning mattress surfaces is done the same as carpeted stairs. To begin, set the Kirby Hand Portable on the mattress. With the Brush Roll engaged, turn the Kirby ON and lower the power nozzle to its lowest setting. Engage TechDrive® and begin to vacuum. □

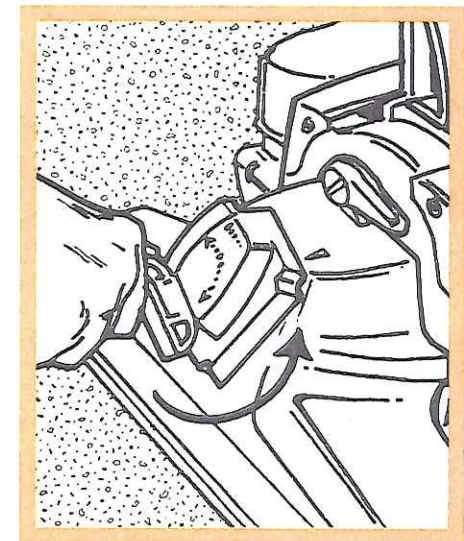

DELICATE MATTRESS  
CLEANING

Cleaning soft or delicate mattress surfaces is done the same as regular mattress surfaces, except that you may want to disengage the Brush Roll. (If your mattress has tufted buttons on the surface, the Brush Roll could pull them loose.)

For straight suction cleaning, raise the Headlight Hood ⑪ and flip out the L-shaped handle on the Belt Lifter ⑫. Use it to turn the Belt Lifter all the way to the left (counter-clockwise) until the red arrows line up. This will stop the Brush Roll from turning.

Return the L-shaped handle on the Belt Lifter to its closed position and lower the Headlight Hood. Use the Toe-Touch Control to adjust the Power Nozzle to its lowest setting. □



# Canister Cleaner & Attachments

## PART THREE

Your G5™ comes with a wide variety of attachments for added versatility. In this section, we will discuss the following:

**Removing the Power Nozzle to Convert to a Canister Cleaner**

**Using Extension Tubes**

**Using the Surface Nozzle, Duster Brush, Upholstery Nozzle, Crevice Tool, Wall & Ceiling Brush and the Massage Cup**

**Using the Suction Control Grip**

**Using your G5™ as a Blower Unit**

**Using the Portable Sprayer and the Portable Shampooer™**

This section will add even greater value to your G5 by providing information you need to use attachments for a wide variety of jobs.

# Canister Cleaner & Attachments

## Installing the Attachment Hose

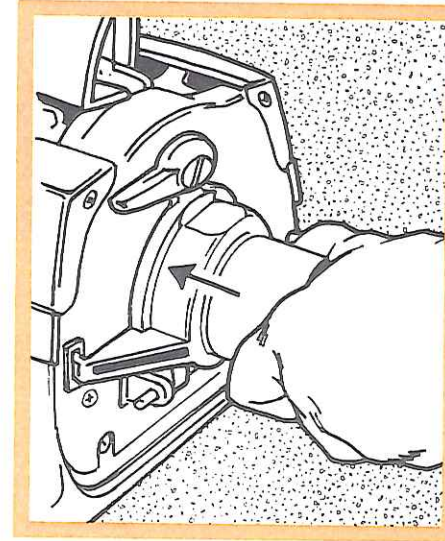
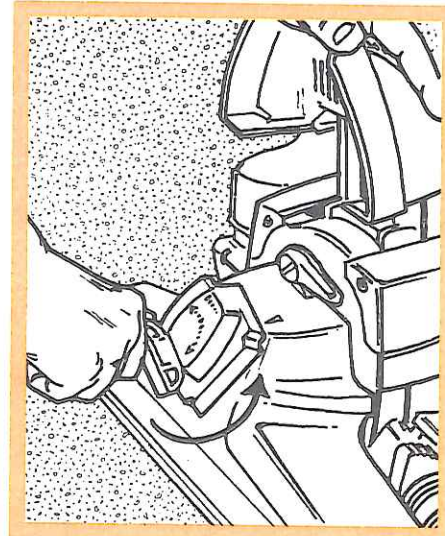
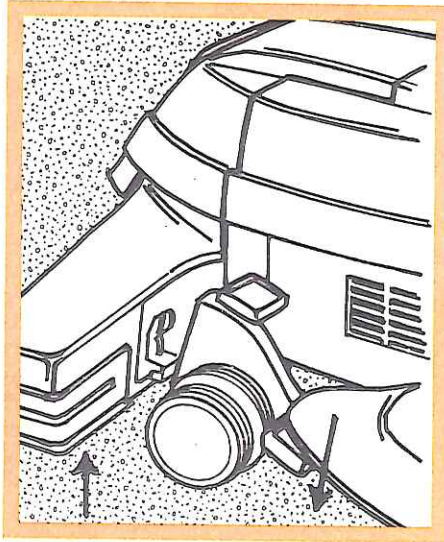

### INSTALLING THE ATTACHMENT HOSE

When using different cleaning attachments, the Attachment Hose is connected to the front of the cleaner in place of the Power Nozzle (25).

NOTE: When connecting the Attachment Hose, you may choose between the Upright Handle (17) or the Portable Handle (15). To install the Portable Handle, see page 14.

**1** To install the Attachment Hose, you must first remove the Power Nozzle. To do so, press the Toe-Touch Control™ Bottom Pedal (9) all the way down until nozzle is fully raised. Disengage TechDrive® by stepping on the light gray “N” side (marked “N” for Neutral) of the TechDrive Power Assist N/D Pedal (11). Turn the Kirby® OFF by pressing the Power Switch (13) and then unplugging. ➤

**2** Raise the Headlight Hood (21) and flip out the L-shaped handle on the Belt Lifter (20). Use it to turn the Belt Lifter all the way to the left (counter-clockwise) until the red arrows line up.

**3** Unlock the Power Nozzle by turning the Accessory Lock (22) all the way to the left (counter-clockwise). The Power Nozzle should tip forward when it is released. Lift the nozzle away from the Kirby and off. ➤

**4** At the connector end of the Attachment Hose, you will notice two hook-shaped lugs. Hook the lugs over the ends of the Attaching Bar (24), then push the opening of the hose up against the Kirby. ➤

**5** Lock the Attachment Hose Connector in place by turning the Accessory Lock (22) all the way to the right (clockwise). (The Accessory Lock will clamp the Attachment Hose against the Kirby.)

With the Attachment Hose in place, Kirby will automatically adjust to his speed for hose operation.

NOTE: If the Kirby will not run when the Power Switch is ON, see page 5, column 2, item 4. □

#### ⚠ CAUTION:

In normal operation, friction between the belt and the metal motor shaft may cause the metal motor shaft to become hot to the touch.

# Canister Cleaner & Attachments

## Installing/Using the Attachments

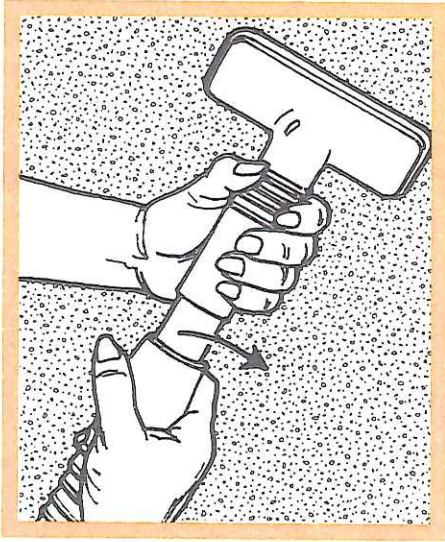

**INSTALLING ATTACHMENTS  
ON THE ATTACHMENT HOSE**

To attach tools to the hose, push lightly while twisting the smaller end of the hose into the tool. □

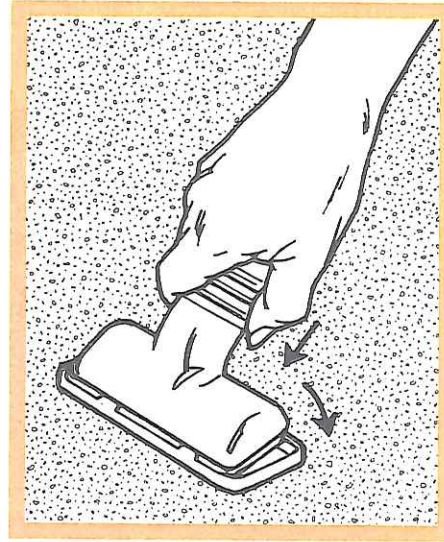

**ATTACHING THE SUCTION  
RELIEF UPHOLSTERY PANEL**

To attach the suction relief faceplate for drapes and delicate upholstery, insert the lip on the front edge of the upholstery tool under the two tabs on the front of the suction relief faceplate as shown.

Push down the rear of the upholstery tool as shown to snap the suction relief faceplate into place.

To remove the suction relief faceplate, reverse the above procedure. □

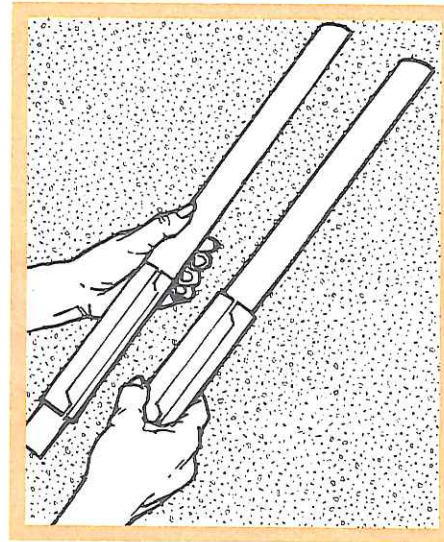

**EXTENSION TUBES**

One or two Extension Tubes can be attached to the end of the hose to extend your reach and efficiently use various attachments. □

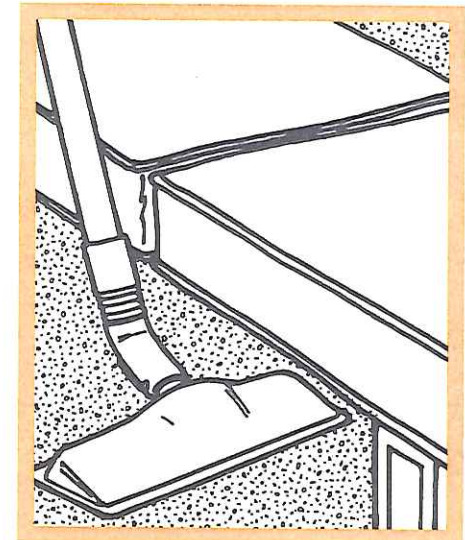

**SURFACE NOZZLE**

The Surface Nozzle may be used on bare floors or for surface cleaning carpets and under low furniture.

Rubber wheels on the nozzle allow it to glide silently on the surface of hard floors without scratching and vacuum with maximum power. □

# Canister Cleaner & Attachments

## Using the Attachments

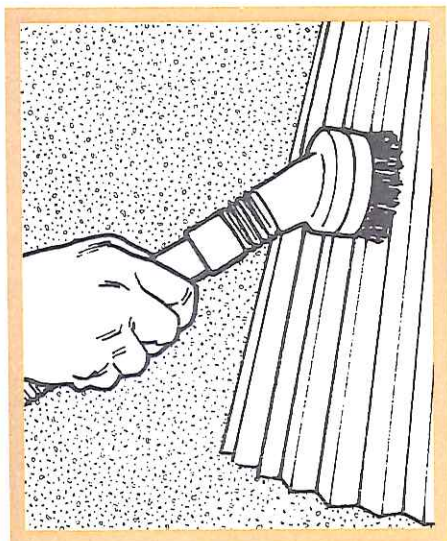

DUSTER BRUSH

The Duster Brush may be connected to the Attachment Hose or the Extension Tubes to remove dust from any surface, including contoured or irregular surfaces. □

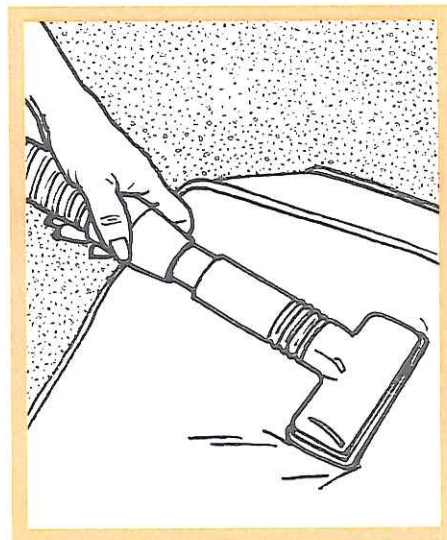

UPHOLSTERY NOZZLE

The Upholstery Nozzle is used for cleaning upholstered furniture, carpeted steps, clothing and inside of cars. □

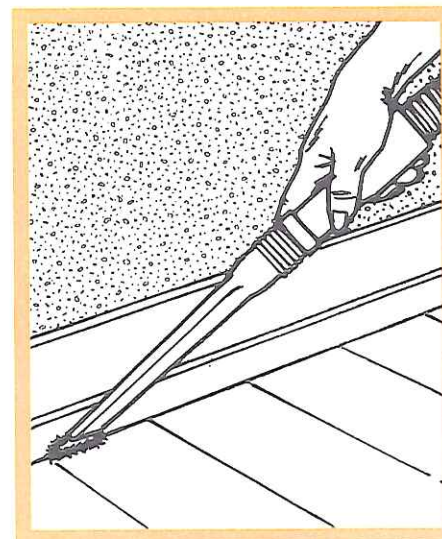

CREVICE TOOL WITH  
REMOVABLE BRUSH

Without the removable brush, the Crevice Tool can be used for cleaning cracks, crevices, corners, grooves and narrow openings.

Install the removable brush in the end of the Crevice Tool to remove dirt from corners, button tufts, between radiator coils and sliding window tracks. □

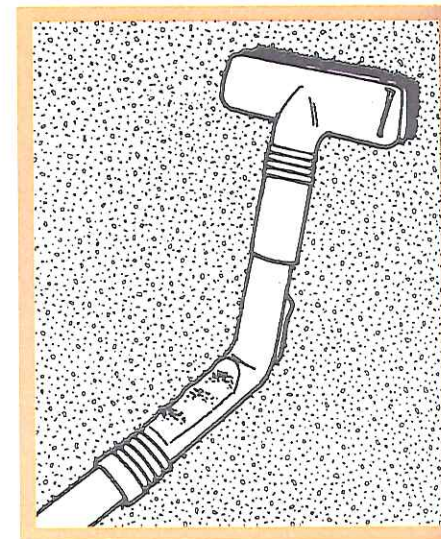

WALL & CEILING BRUSH

To vacuum walls, ceilings, drapes and other surfaces, attach the Wall & Ceiling Brush to the Suction Control Grip (shown on page 21). Then attach the Suction Control Grip to the Extension Tube(s) as shown. In addition to providing suction relief, the Suction Control Grip provides the proper angle to comfortably vacuum walls and ceilings.

Tip: To vacuum the top of door frames or ledges, or books on a bookshelf, rotate the Wall & Ceiling Brush 180°.

NOTE: You may also wish to use the Suction Control Grip as shown on page 21. □

# Canister Cleaner & Attachments

## Using the Attachments/Using Your G5™ as a Blower

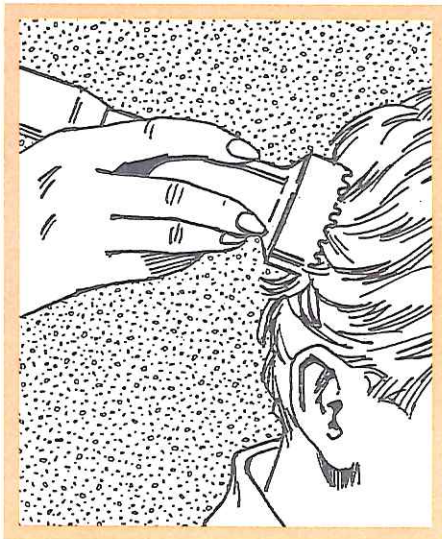

### MASSAGE CUP

Used with the Attachment Hose, the Massage Cup provides an invigorating skin or scalp massage. It can also be used to clean the floors of cars. □

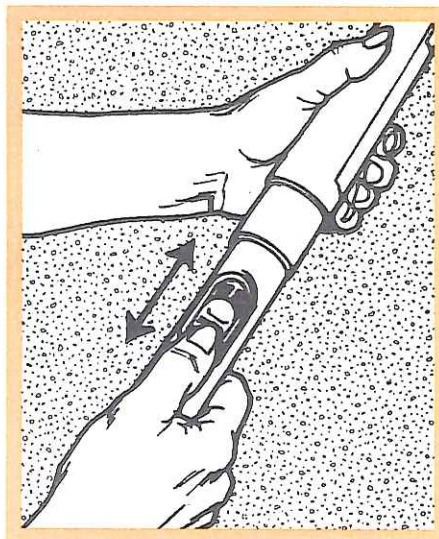

### CONTROLLING AIRFLOW WITH THE SUCTION CONTROL GRIP

Sometimes when using the attachments, vacuuming drapes or delicate lamp shades, for example, you might wish to control the amount of suction.

The Suction Control Grip features a valve to control the amount of suction. Slide the control back and forth until the desired level of suction is reached.

The Suction Control Grip can be used with or without the Extension Tubes. □

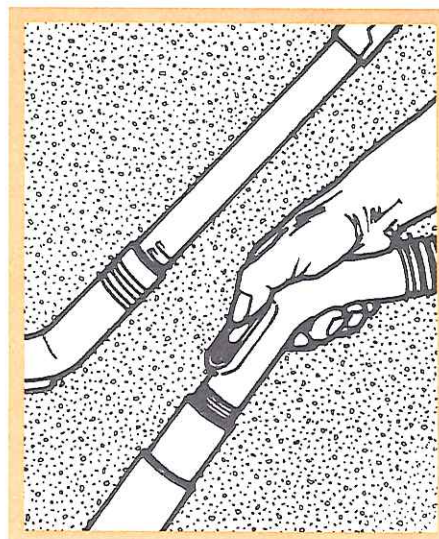

### SUCTION CONTROL GRIP PLACEMENT

The Suction Control Grip may be used at the end of the Extension Tubes for reaching up or at the beginning of the Extension Tubes for reaching down. □

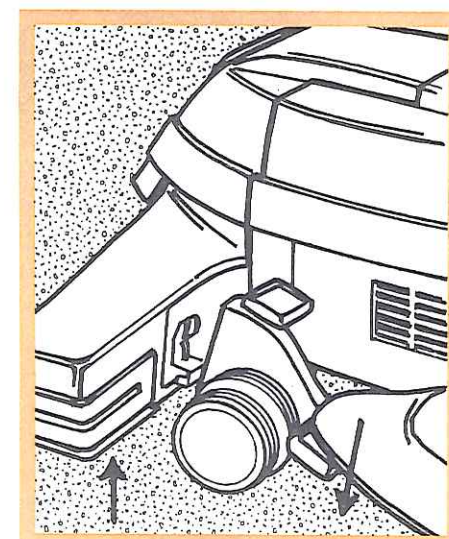

### BLOWER SET-UP

Your G5 can also be used as a blower. To do so, you must first remove the Power Nozzle (25).

NOTE: When using your G5 as a blower, you may choose between the Upright Handle (17) or the Portable Handle (15). To install the Portable Handle, see page 14.

**1** Turn the power OFF, place the TechDrive® Power Assist in Neutral (see page 8 for details), unplug the Kirby® from the wall outlet and press the Toe-Touch Control™ Bottom Pedal (9) all the way down until nozzle is fully raised. ➤

# Canister Cleaner & Attachments

Using your G5™ as a Blower (continued)

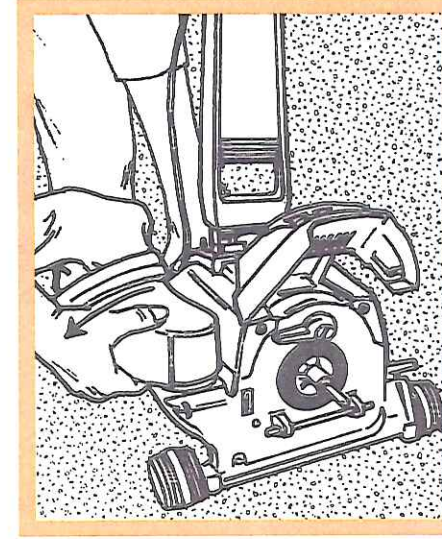
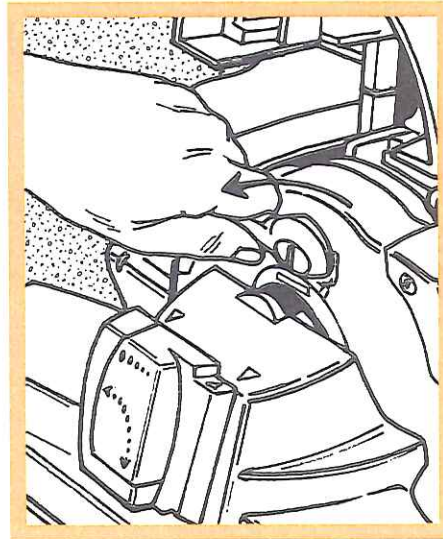
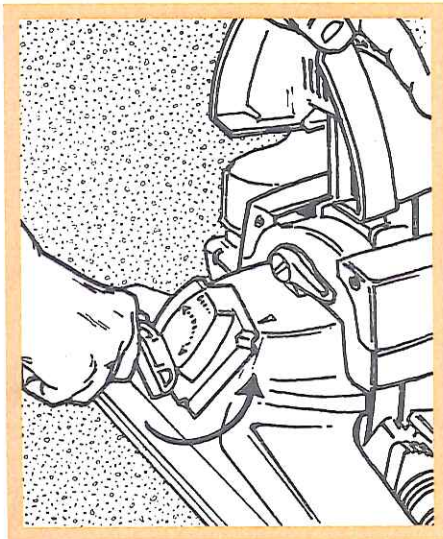

## BLOWER SET-UP (cont)

**2** Raise the Headlight Hood (21) and flip out the L-shaped handle on the Belt Lifter (20). Use it to turn the Belt Lifter all the way to the left (counter-clockwise) until the red arrows line up. ➤

**3** Unlock the Power Nozzle (25) by turning the Accessory Lock (22) all the way to the left (counter-clockwise). The Power Nozzle should tip forward when it is released. Lift nozzle away from the Kirby® and off. ➤

**4** When using the blower attachments, the Air Intake Guard must be attached to the front of the Kirby.

Fasten the Air Intake Guard onto the Attaching Bar (24) the same way you would the Attachment Hose. Then lock it on by turning the Accessory Lock (22) all the way to the right (clockwise). ➤

**5** To remove the entire Bag Assembly, grasp the Mini Em-Tor® (6) in the hand-hold provided and rotate it out and away from the Kirby as far as it will go. Then lift it off.

(To replace the Bag Assembly after use as a blower, see page 9.) ➤



# Canister Cleaner & Attachments

Using Your G5™ as a Blower (continued)

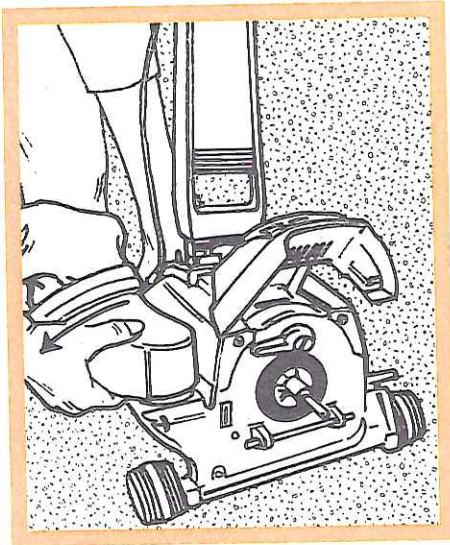

BLOWER SET-UP (cont)

**6** Release the Outer Permanent Bag Top from the Bag Support (16) by pressing the Bag Release Button (16) and sliding the bag top down. (See page 14 for details.) ➤

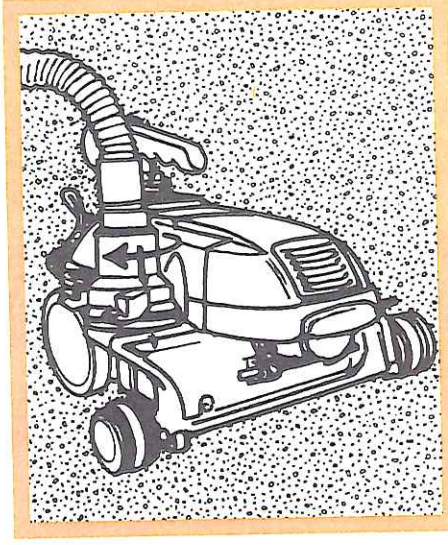

**7** Place the large end of the Attachment Hose over the Air Exhaust Port (19). Line up the Indicator Arrow on the Hose End with the Indicator Arrow on the Air Exhaust Port and twist the Hose Connector to the right (clockwise) to lock it in place.

If the Kirby® will not operate, see page 51, column 2, items 4 and 5. ☐

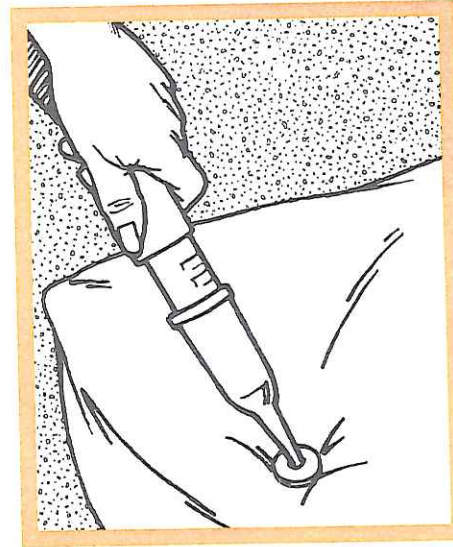

USING YOUR G5™ AS A BLOWER

Your G5 may now be used as a blower. By attaching the Inflator/Deflator Tool to the Attachment Hose, you can inflate toys, air mattresses or any other low-pressure inflatable item up to 1 p.s.i. (pounds per square inch of air pressure). ➤

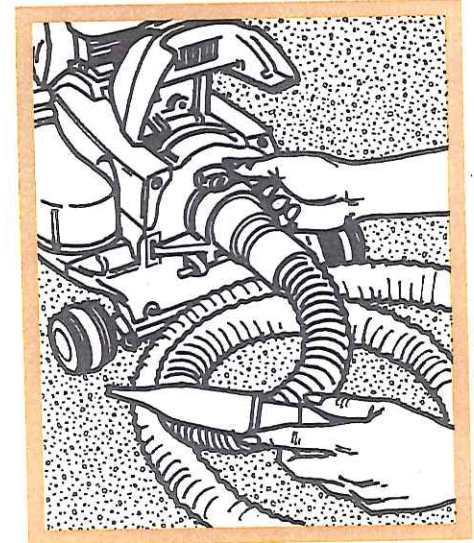

To deflate items, connect the Attachment Hose to the front of the Kirby (see page 18 for details) and connect the Inflator/Deflator Tool to the Attachment Hose. Then connect the Bag Assembly to the Air Exhaust Port (see page 9).

You may now use your Kirby to deflate items.

NOTE: You can also use this set-up to clean tight areas such as computer keyboards and audio/video equipment. ☐

# Canister Cleaner & Attachments

## The Portable Sprayer (Blower Mode Only)



THE PORTABLE SPRAYER

The Portable Sprayer is used only in the Blower Mode. It is an excellent tool to apply many different types of **water-based** liquids to any type of surface. The spray can be adjusted ranging from very fine to coarse.

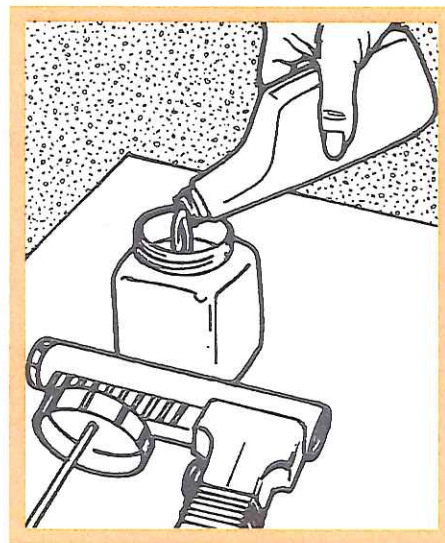

PORTABLE SPRAYER SET-UP

- 1 Unscrew the jar from the Portable Sprayer and fill 3/4 full with non-flammable liquid. ➤



- 2 Screw the jar tightly on the Portable Sprayer and attach the Portable Sprayer to the end of the Attachment Hose in the Blower Mode (see page 21).

Make certain your Kirby® is set up as a Blower Unit. The Attachment Hose should be connected to the Air Exhaust Port (19). □

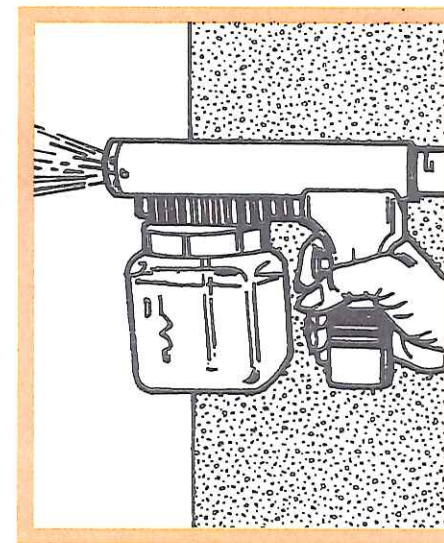

USING THE PORTABLE SPRAYER

- 1 Holding the Portable Sprayer horizontally, aim it toward a sheet of newspaper. Turn the Kirby ON and squeeze the Portable Sprayer trigger, spraying your non-flammable solution onto the newspaper to check spray pattern.

NOTE: If the Portable Sprayer must be tilted during usage, less solution should be used in the jar. This will help avoid large droplets in the spray. ➤



**WARNING:**

Never use oil or solvent base paint of any kind in the Portable Sprayer. The motor is open to the spray and could ignite flammable and volatile solvents.

# Canister Cleaner & Attachments

## The Portable Sprayer

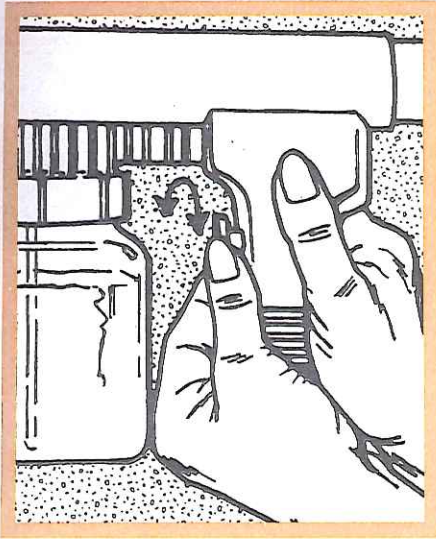

### USING THE PORTABLE SPRAYER (cont)

**2** With the nozzle pointed away from you, adjust the spray by turning the Spray Adjustment Control on the trigger of the Portable Sprayer. ➤

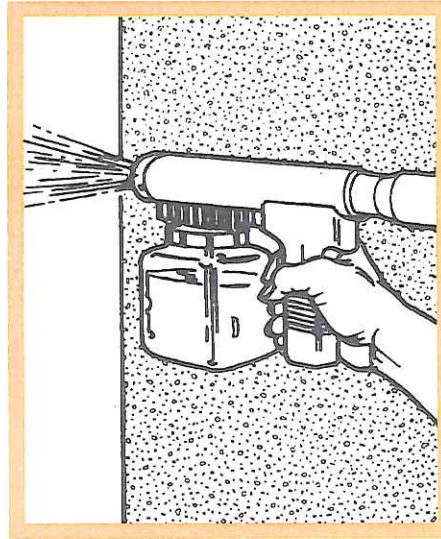

**3** Use slow, sweeping motions to spray the desired area with solution. Always squeeze the trigger fully to permit maximum flow. This will give you the best spray control. □

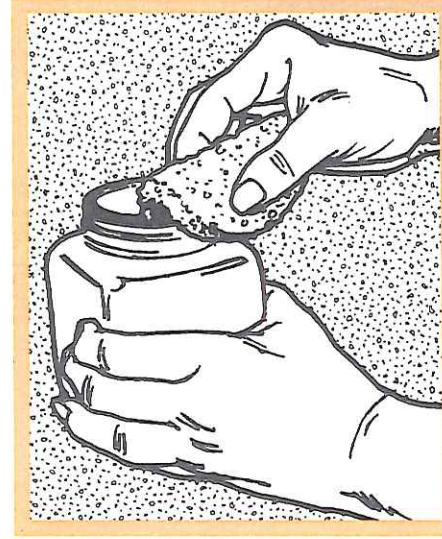

### CLEANING THE PORTABLE SPRAYER

**1** Immediately after use, empty the Portable Sprayer jar and wash with warm soapy water. ➤



**2** The Portable Sprayer dip tube should also be removed and washed. (Make sure to reinstall it after cleaning.) ➤



#### WARNING:

Never clean the Portable Sprayer with flammable cleaning fluids. The motor is open to the spray and could ignite the spray.

# Canister Cleaner & Attachments

The Portable Sprayer (continued)/The Portable Shampooer™

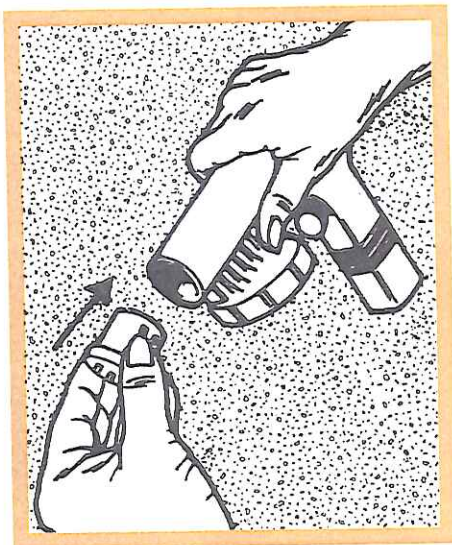

## CLEANING THE PORTABLE SPRAYER (cont)

**3** The spray opening on the front of the Sprayer also pulls out so that the inside of the Sprayer and the nozzle jet can be cleaned.

To remove the nozzle jet, press on the two latches on the front of the nozzle jet and pull it out. (The latches must be aligned with the holes on the front of the Sprayer when returning the nozzle jet to the front of the Sprayer.)

Then, fill the jar with water. Spray water until the spray becomes clear. Reassemble the Sprayer after cleaning so none of the parts will be lost. □



## PORTABLE SHAMPOOER SET-UP

The Portable Shampooer is used in the Blower Mode only (see page 21 for details). It is designed for fast and easy cleaning of carpeted stairways and areas that are difficult to reach with the Carpet Shampoo System.

**1** To set up the Portable Shampooer, attach the Portable Shampooer cap to the end of the Portable Sprayer. ➤

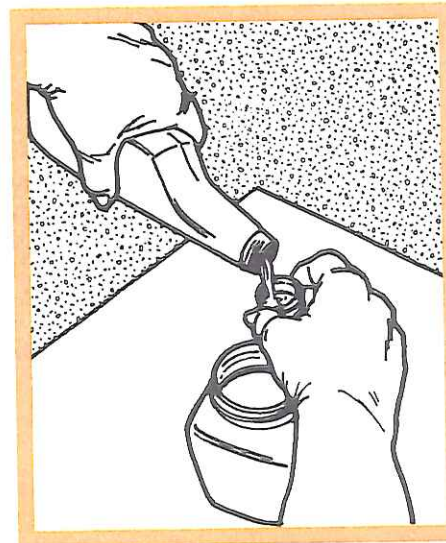

**2** Remove the jar from the Portable Sprayer and fill the jar about 3/4 full with Kirby® Carpet Shampoo mixture (Mix according to the instructions on the bottle.) USE ONLY KIRBY CARPET SHAMPOO for best results. ➤

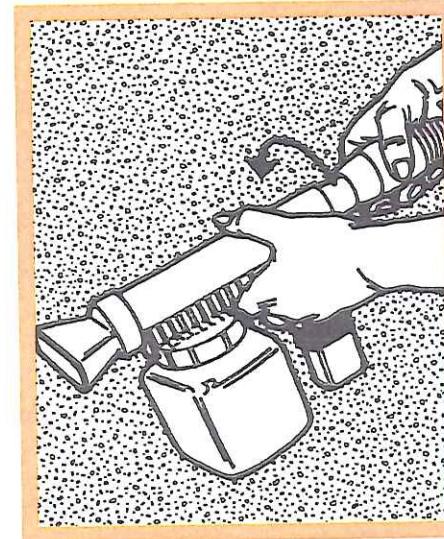

**3** Screw the jar tightly on the Portable Sprayer, then attach the Sprayer to the Attachment Hose.

(Make certain your Kirby is set up as a Blower Unit. The Attachment Hose should be connected to the Air Exhaust Port (19) - see page 23.) □

# Canister Cleaner & Attachments

The Portable Shampooer™

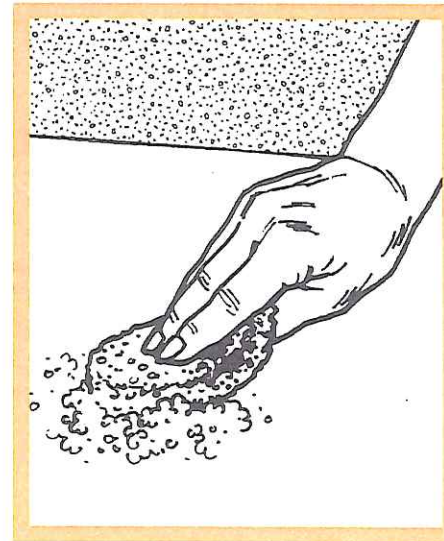
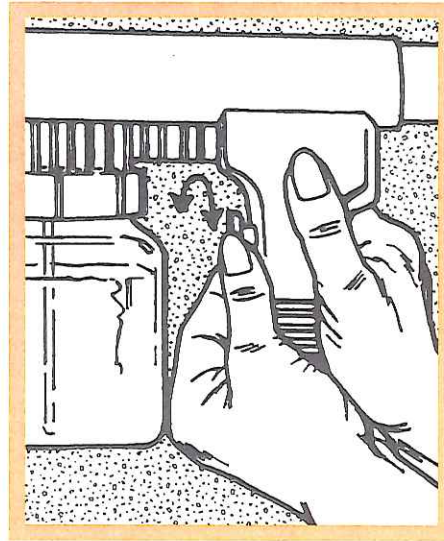
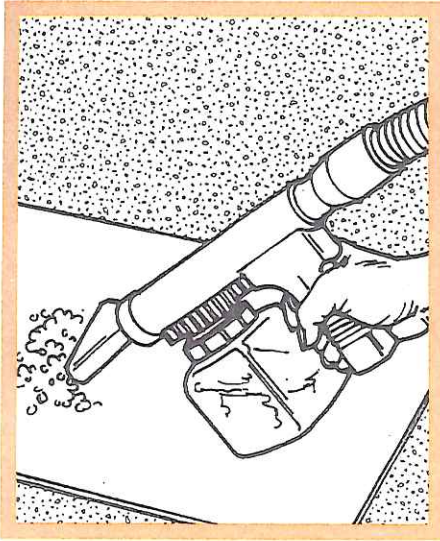

## USING THE PORTABLE SHAMPOOER

- 1** Before shampooing, vacuum surface thoroughly.  
To make suds, turn the Kirby® ON and pull the trigger of the Portable Sprayer. A stream of suds will come out of the cap.

The suds can be sprayed directly onto the surface being cleaned or on a plain paper bag or in a bowl and then applied to the surface being cleaned. ➤

- 2** Adjust the Portable Sprayer for proper suds volume by turning the Spray Adjustment Control located on the trigger. ➤

- 3** Work suds into the surface with a soft brush or sponge until they disappear. Allow the surface to dry completely.

Then vacuum with the appropriate cleaning tool. This will remove the dry residue which contains grime and loosened dirt. ☐

**⚠ CAUTION:**

The Portable Shampooer is not recommended for use on upholstery or fabrics such as silk, brocade and velvet. If in doubt, try a test patch. Let the test patch dry and then check it before you shampoo further.



# Optional Accessories

## PART FOUR

Optional Kirby® Accessories greatly enhance the usefulness of your new G5™. In this section, we will discuss the following:

**Using the Carpet Shampoo System**

**Using the Floor Care System**

**Using the Turbo Accessory System™**

**Using the Zippbrush™**

This section will provide the information you need to take advantage of your Kirby Optional Accessories.

# Optional Accessories

## The Carpet Shampoo System

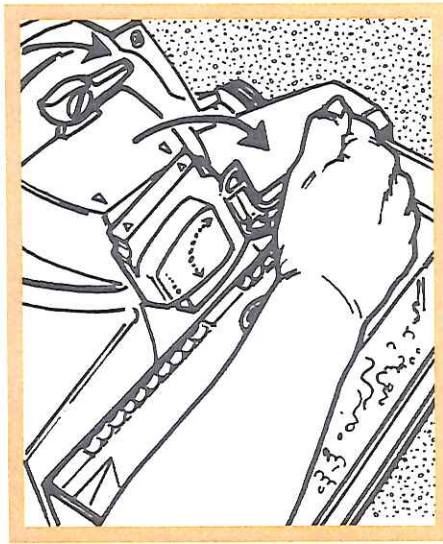

### CARPET SHAMPOO SYSTEM SET-UP

Vacuum thoroughly before shampooing for maximum cleaning. Then, remove the Outer Permanent Bag (1) and the Power Nozzle (25) to prepare for shampooing.

**1** By using the L-shaped handle, turn the Carpet Shampoo System Nozzle Belt Lifter to the right (clockwise) until the green arrows line up. ➤

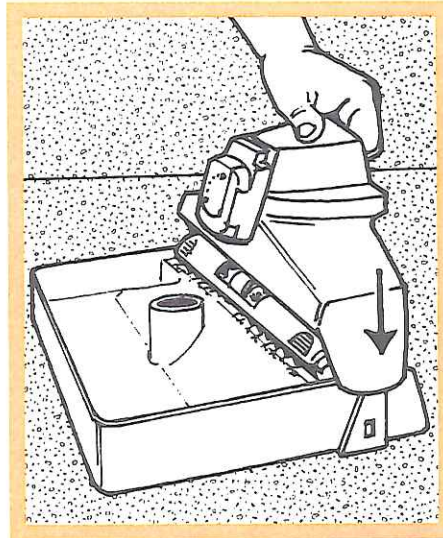

**2** Slide the slots on the side of the Carpet Shampoo System Nozzle over the outer shoulders of the Carpet Shampoo System Tray. ➤

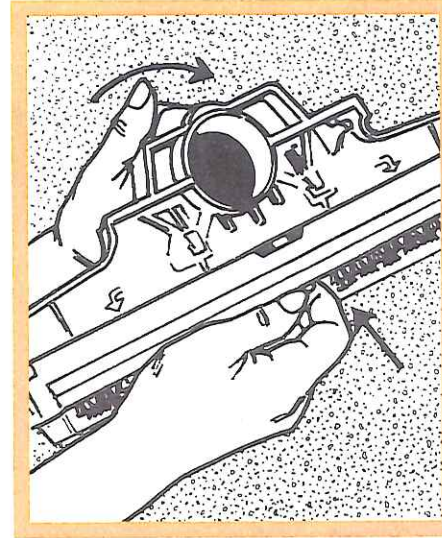

**3** While pushing up on the belt with your finger, use the L-shaped handle on the Belt Lifter to turn it left (counter-clockwise looking at it from the front) until the red arrows line up. (The Belt Lifter Hook will catch and stretch the belt.) ➤

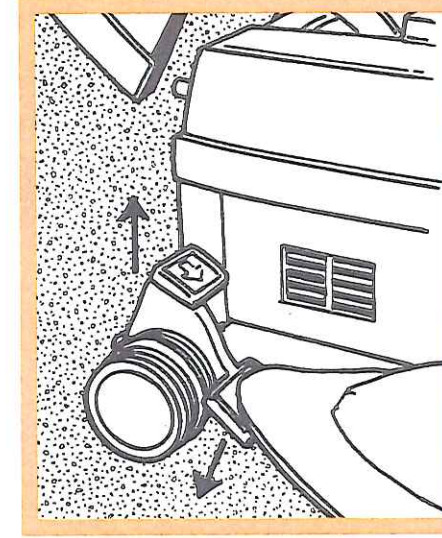

**4** Press the Toe-Touch Control™ Bottom Pedal (9) all the way down to raise the front of the Kirby®. ➤



# Optional Accessories

## The Carpet Shampoo System

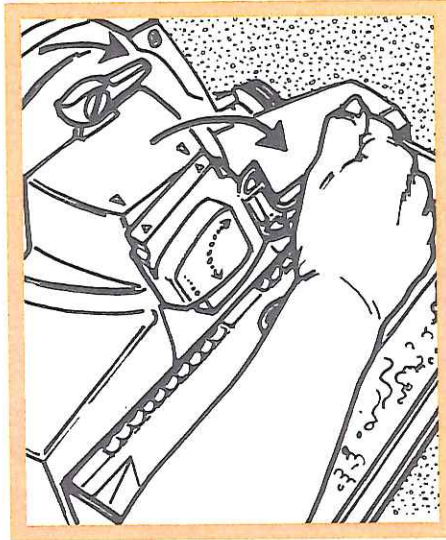
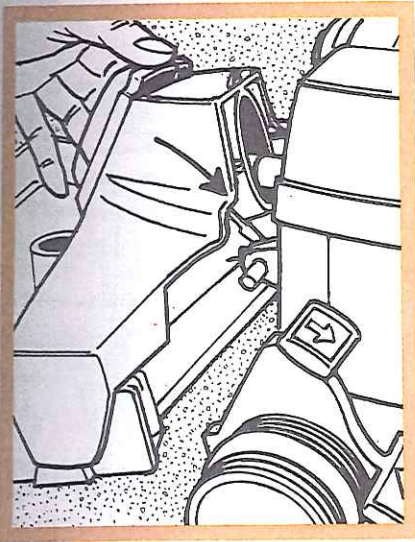

### CARPET SHAMPOO SYSTEM SET-UP (cont)

**5** While sliding the Carpet Shampoo System Nozzle/Tray Assembly toward the Kirby® and over the Motor Shaft (23), connect the hooks on the bottom rear of the nozzle to the Attaching Bar (24). ➤

**6** Push the nozzle up against the Kirby and turn the Accessory Lock (22) to the right (clockwise) to lock the nozzle in place. To engage the belt, use the L-shaped handle on the Belt Lifter to turn it all the way to the right (clockwise) until the green arrows line up. Then lower the Headlight Hood (21). ➤

**7** The Shampoo Tank is removable and should be filled or emptied at your sink.

**NOTE:** The Shampoo Tank is removed and re-attached in the same way as the Mini Em-Tor® (see page 9 for details).

Unscrew the large cup from the top of the Shampoo Tank and turn the Suds Control Valve fully to the left (counterclockwise) to OFF.

Holding the Shampoo Tank level, fill it to the full line with warm water (not hot).

Using the large cup from the top of the tank, pour three cupfuls of Kirby Carpet Shampoo into the Shampoo Tank. Do not use more, as over-foaming will result. ➤

**NOTE:** One tankful of solution will clean about a 10x12 foot carpet (3x3.5m). Larger carpets will require refilling the Shampoo Tank.

Replace the large cup into the opening on top of the Shampoo Tank. ➤

# Optional Accessories

## The Carpet Shampoo System (continued)

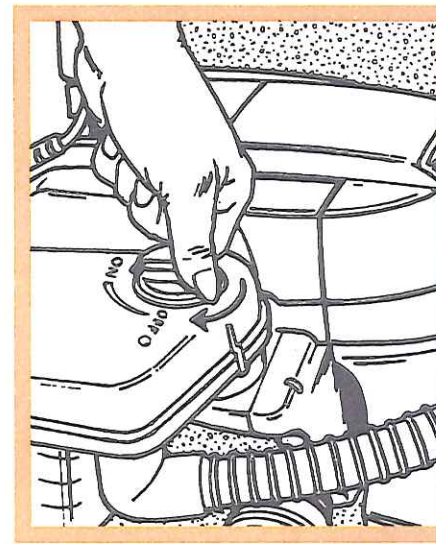
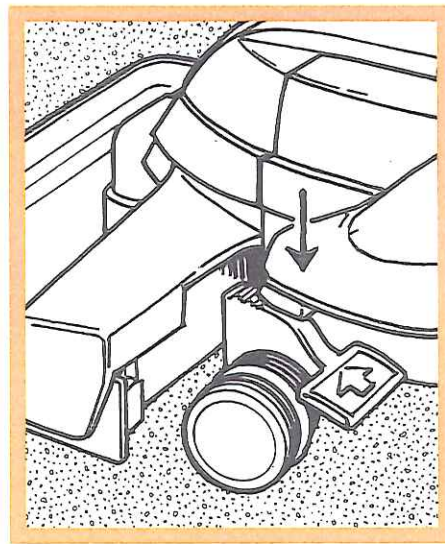
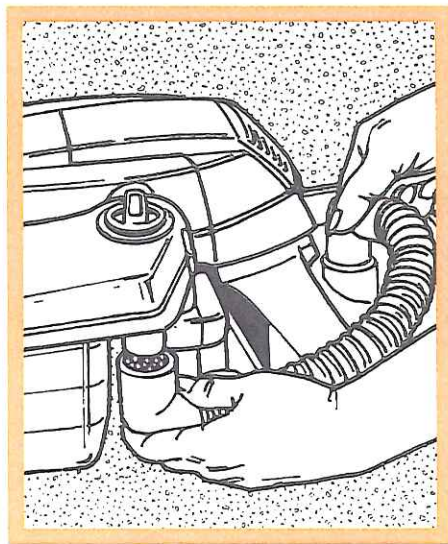
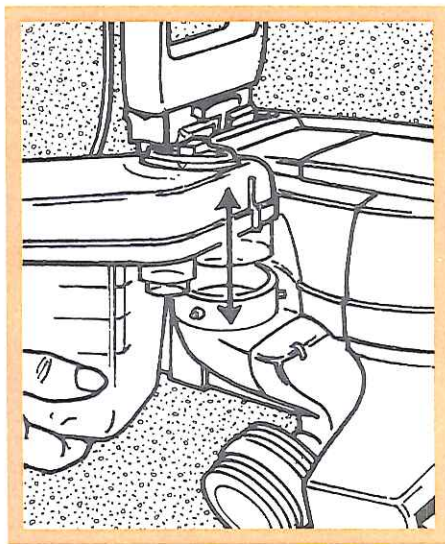

### USING THE CARPET SHAMPOO SYSTEM

**8** Taking care to avoid spilling liquid on the Kirby® or the floor, place the opening in the bottom front of the Shampoo Tank over the Air Exhaust Port (19) on the Kirby. Angle the Shampoo Tank outward from the Kirby until the arrows line up. Next, slide the Shampoo Tank down over the locking pins on the Air Exhaust Port.

Rotate the Shampoo Tank toward the Kirby (clockwise) to lock it in place. ➤

**9** Push the round elbow into the hole in the tray until it snaps into place. Firmly insert the other end over the fitting at the bottom front of the Shampoo Tank. □

**1** To set the nozzle to the proper height, step on the Toe-Touch Control™ Upper Pedal (8) as often as necessary to lower the nozzle to its lowest position. ➤

**2** Turn the Suds Control Valve all the way to the right (clockwise) to the ON position. Turn the Kirby ON and engage TechDrive® Power Assist (see page 7 for details). Suds flow will begin immediately.

Control the amount of suds by turning the Suds Control Valve left (counter-clockwise) for decreased suds flow and right (clockwise) for increased suds flow. Turning the valve all the way to the left (counter-clockwise) to the OFF position will stop the flow of suds completely.

Stopping the flow of suds allows you to thoroughly brush all the suds into the carpet before applying more suds. This also lets you spot scrub badly soiled areas. ➤

# Optional Accessories

## The Carpet Shampoo System (continued)

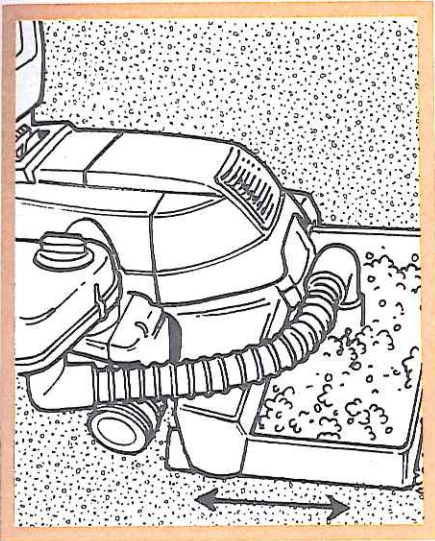

### USING THE CARPET SHAMPOO SYSTEM (cont)

As you move the Kirby® back and forth, foam will be released and the brush will work it into the carpet.

**NOTE:** Suds should be dispensed the full width of the tray when the Kirby is pulled backward. If not, pull back more slowly or check and clean the Shampoo Tank Filter, if necessary (see page 35).

After suds have been on the carpet at least five minutes, pick up the foam by turning the Shampoo Tank to the OFF position. With the Kirby at its lowest height level, move the Shampooer over the foam until the foam is picked up. Some moisture will accumulate in the front of the tray. Once the carpet is thoroughly dry, vacuum with the Kirby Upright (see page 12). □

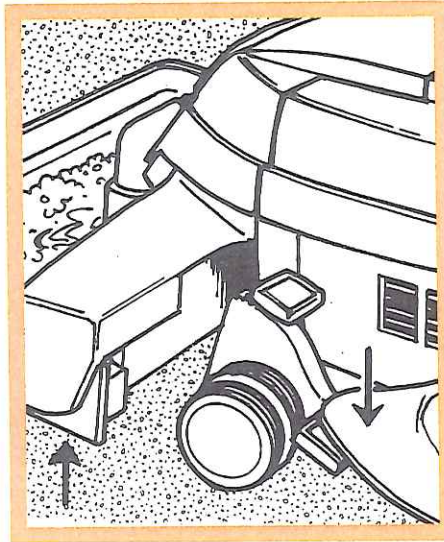

### CLEANING THE CARPET SHAMPOO SYSTEM

**1** Push the Toe-Touch Control™ Bottom Pedal (9) all the way down to raise the nozzle and tray, then turn the Kirby OFF and unplug it. ➤

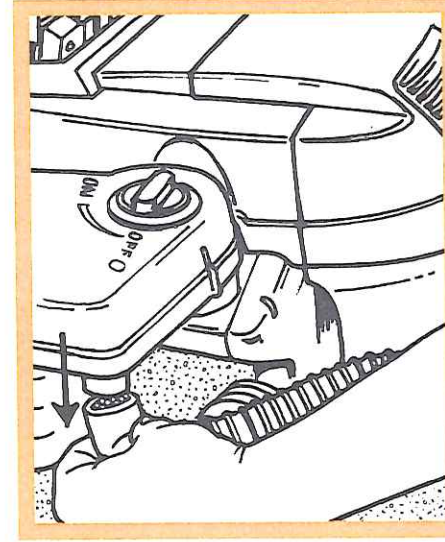

**2** Turn the Suds Control Valve fully to the left (counter-clockwise) to the OFF position .  
Pull the Small Flexible Hose from the Shampoo Tank, but not from the tray. ➤

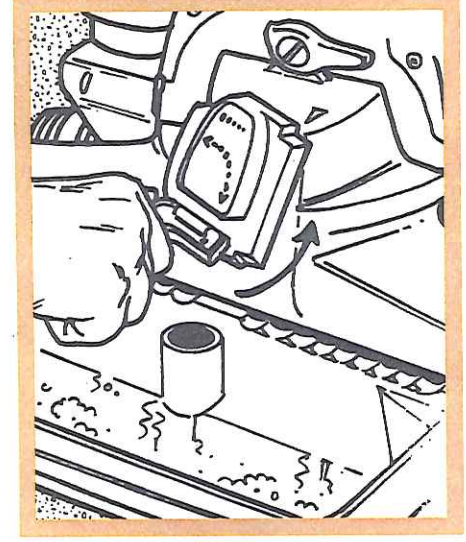

**3** Raise the Headlight Hood (21) .  
Release the belt by turning the Belt Lifter to the left (counter-clockwise) until the red arrows line up. ➤

# Optional Accessories

## The Carpet Shampoo System (continued)

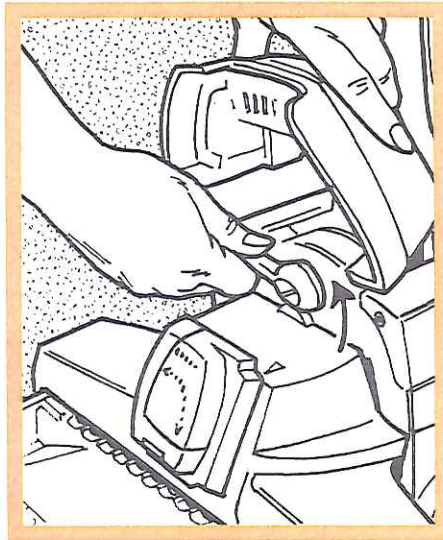

### CLEANING THE CARPET SHAMPOO SYSTEM (cont)

**4** Turn the Accessory Lock (22) to the left (counter-clockwise). The Carpet Shampoo System Nozzle/Tray Assembly will tip forward.

Lift the Nozzle/Tray Assembly off the Kirby® and carry it to the sink. ➤



**5** By using the L-shaped handle, turn the Belt Lifter to the right (clockwise) until the green arrows line up. Pull the tray and nozzle apart. ➤

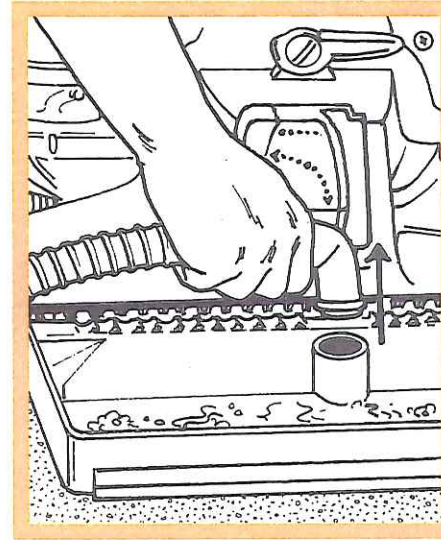

**6** Remove the hose from the tray and rinse them both. ➤



**7** To clean the brush, push the thumb pads located at each end of the plastic shield and rotate the shield up and away from the brush.

Disconnect the shield by gently pulling out the ends of the tray just behind the Brush Roll.

Push the Brush Roll down out of the tray by simultaneously pushing on both ends of the brush with both thumbs.

Rinse all areas of the shield tray and brush, and remove any lint from brush tufts.

Shake excess water from the Brush Roll by brushing hand over the bristles and then drying with a towel. ➤

# Optional Accessories

## The Carpet Shampoo System (continued)

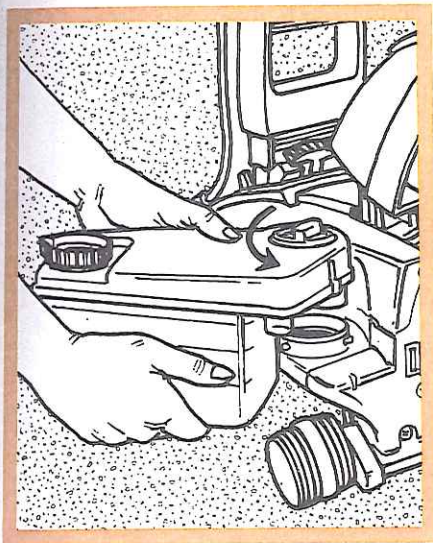

### CLEANING THE CARPET SHAMPOO SYSTEM (cont)

**8** To remove the Shampoo Tank from the Air Exhaust Port (19), rotate it away from the Kirby® as far as it will go, then lift it upwards. ➤

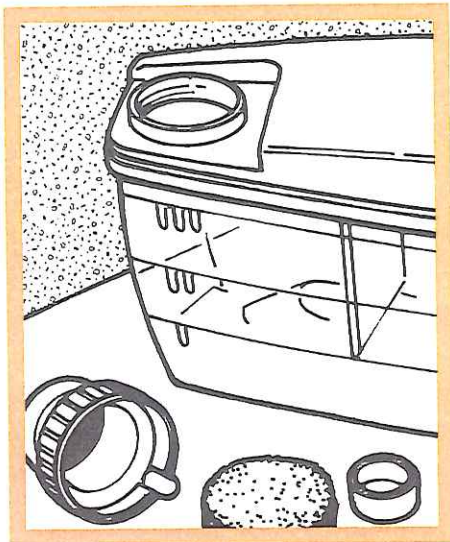

**9** Remove and clean the Suds Screen Cap, Cup and Sponge Filter.

Rinse out the Shampoo Tank with cold water and replace the Screen Cap, Cup and Sponge Filter.

NOTE: The belt should not be stretched for extended periods. Make sure the green arrows on the nozzle line up for storage. (Remember to align the red arrows before replacing the nozzle on the Kirby - see Belt Lifter section on page 9.) □



### REPLACING A WORN CARPET SHAMPOO SYSTEM NOZZLE BELT

**1** To replace the Carpet Shampoo System Nozzle Belt, push the thumb pads located at each end of the shield and rotate the shield up and away from the brush. ➤



**2** Push down carefully on the ends of the brush with your thumbs. The brush will snap out and the belt can be replaced.

Be certain the belt is placed in the center of the brush. NOTE: Use only approved Kirby belts. ➤

# Optional Accessories

The Carpet Shampoo System (continued)/The Floor Care System-Miracle Waxer™

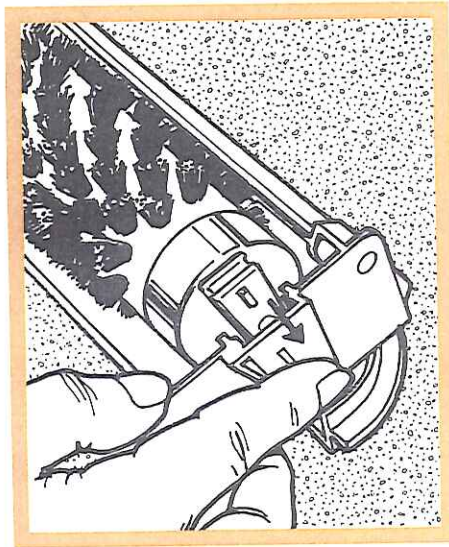

CLEANING THE CARPET SHAMPOO SYSTEM (cont)

**3** Align the metal ends of the brush with the slots on the tray and push the brush in until it snaps into place. The brush will only fit the tray the correct way.

NOTE: The belt should not be stretched when stored for an extended period. Make sure the green arrows line up for storage (see page 9 for discussion of the Belt Lifter). □

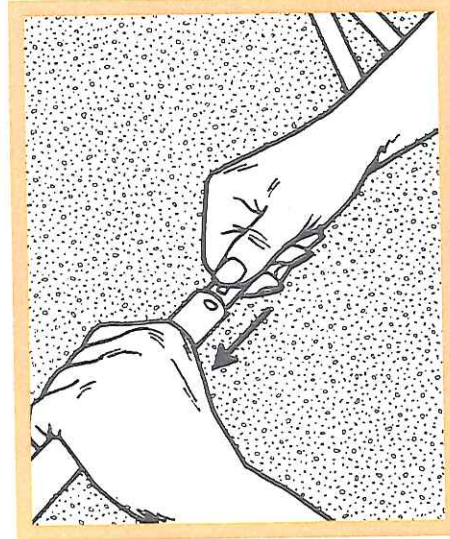

USING THE KIRBY® MIRACLE WAXER™

**1** To assemble the roller waxer applicator, attach the top half of the roller waxer handle to the bottom half (if not already done). Adjust the upper half until the spring-loaded pin in the lower half is seated in the hole near the bottom of the upper half. ➤

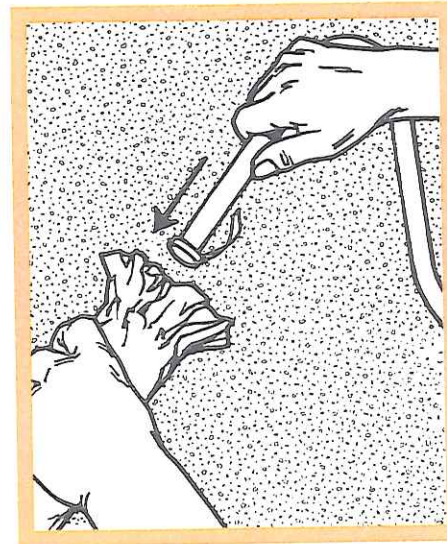

**2** With the wax roller bag facing the hooked end of the long roller handle, push the wax roller over the connector on the bottom of the handle until secure. ➤

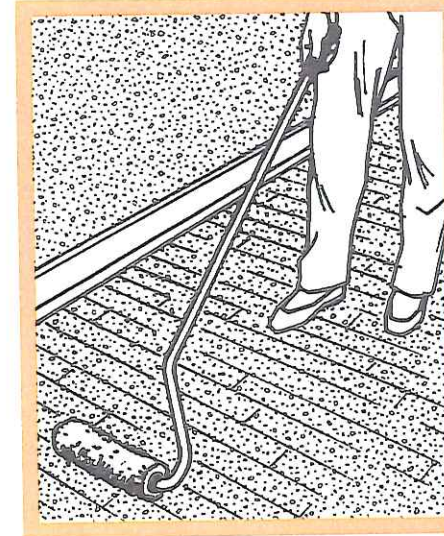

**3** Pull the roller bag off the wax roller and save the packing bag. Begin waxing according to the directions in box below. ➤

## KIRBY MIRACLE WAX DIRECTIONS

For Hardwood, Vinyl, Cork and Linoleum Floors:

1. Clean surface thoroughly.
2. Attach Kirby Floor Care System Buffer Nozzle and Brush according to the instructions on page 37, under "Floor Buffer Set-Up."
3. For best results, apply a very thin coat of Kirby Miracle Wax using the roller applicator. It is not necessary to completely cover the floor with wax at this time, as the wax will be spread in the next step.
4. Using the Toe-Touch Control™ Upper Pedal to lower the nozzle all the way down, spread the wax evenly over the entire floor using the Kirby

Floor Care System Buffer Brush.

5. Let dry 5 minutes.
6. When dry, buff with the Kirby Floor Care System Buffer Brush.

NOTE: For very worn areas, two coats may be required. In this case, multiple thin coats will provide better results than one thick coat.

For Marble Floors:

Apply a thin coat and spread as in the directions in #4. However, buff immediately, avoiding any drying time.

Once you have completed the steps above, the floor may be rebuffered, any time it becomes

necessary, using the Floor Care System Buffer Brush. Apply additional wax ONLY when rebuffering does not produce acceptable results.

## CAUTION:

- A. Do not stand Kirby unit on end for polishing.
- B. For Kirby units with TechDrive®, the TechDrive must be in the Neutral position during polishing.
- C. Do not use Kirby Miracle Wax on rubber or asphalt tile. □

# Optional Accessories

## The Floor Care System-Miracle Waxer™/The Floor Care System-Floor Buffer

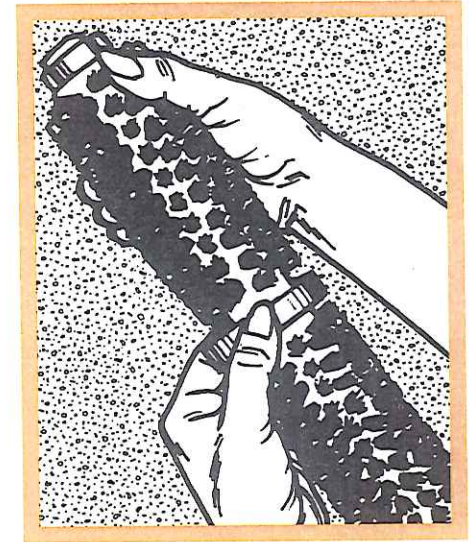
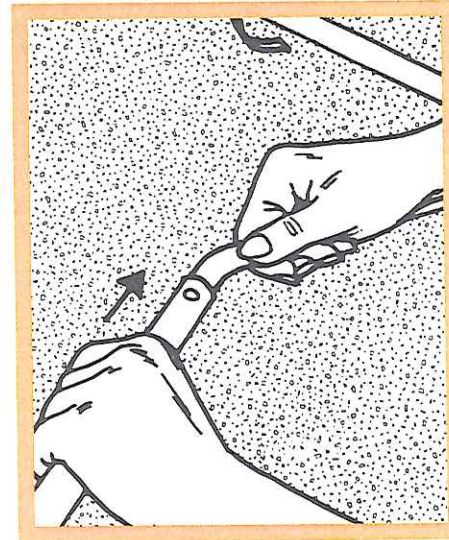
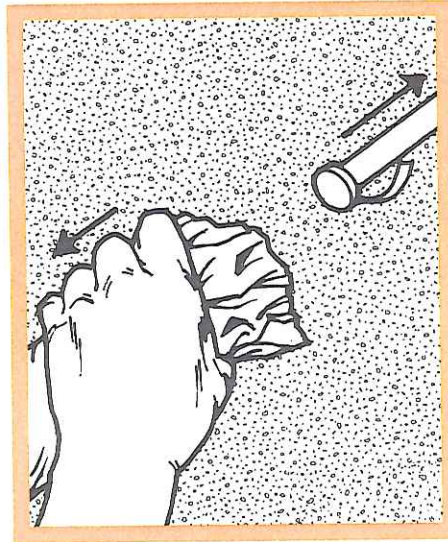
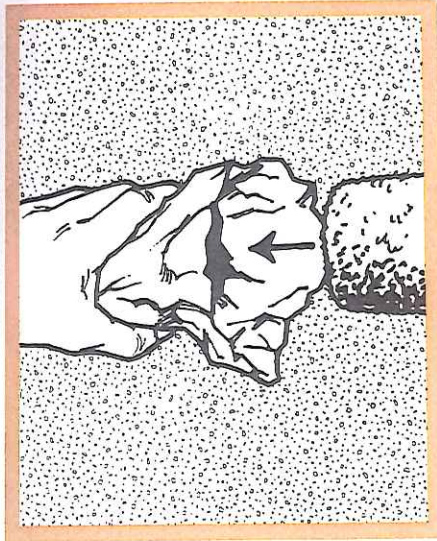

### USING THE KIRBY® MIRACLE WAXER™ (cont)

**4** To remove the wax roller from the long handle, hold the original wax roller packing bag with the open end facing the roller. Push the wax roller into the packing bag as far as it will go. Avoid touching the wax with your hand. ➤

**5** Grasp both the packing bag and roller firmly and pull them off the long roller waxer handle. To do this, push the roller away from the handle grip toward the bar to compress the retaining spring. This will allow you to slide the roller over the end cap. Seal bag tightly to prevent premature drying. Store in the provided packing tube and put in a safe place away from children and pets until next use. ➤

**6** If desired, prepare the long waxer roller handle for storage by depressing the spring-loaded pin on the lower portion of the handle while pushing the upper portion toward the hooked end.

**IMPORTANT:** Seal used roller in original packing bag and tube after each use to prevent the wax from drying out. □

### FLOOR BUFFER SET-UP

Your G5™ can be used as an effective floor buffer for wood or tile floors.

To use the Floor Buffer, you must first insert the Buffer Brush into the Floor Buffer Nozzle.

**NOTE:** Use only approved Kirby belts.

**1** Center the belt of the Buffer Brush in the middle area between the tufts of the brush. ➤

# Optional Accessories

## The Floor Care System-Floor Buffer (continued)

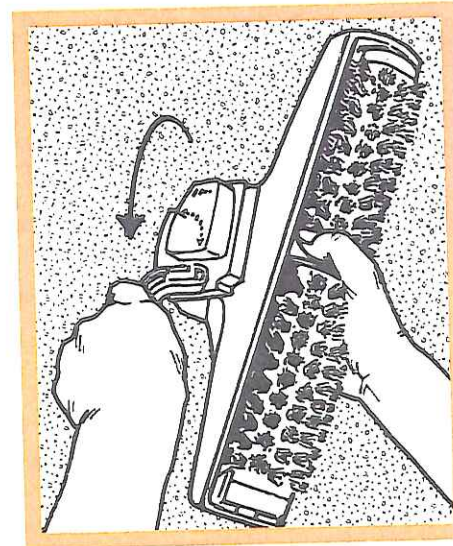
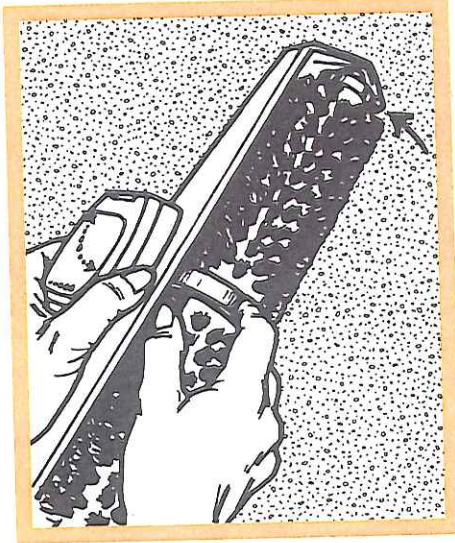

### FLOOR BUFFER SET-UP (cont)

**2** Turn the Buffer Nozzle over and slide the ends of the Brush into the slots at each end of the nozzle. The Buffer Brush will only fit the correct way. ➤

**3** Push the belt up against the Brush Roll with your finger. ➤

**4** While holding the belt in place, use the L-shaped handle on the Belt Lifter to turn it left (counter-clockwise) until the red arrows line up. The Belt Lifter hook will catch the belt and stretch it upward into the nozzle. ➤

**5** Place the hooks located on the rear of the nozzle over the Attaching Bar (24) and push the nozzle up against the Kirby®.

Turn the Accessory Lock (22) to the right (clockwise) to lock the nozzle in place. ➤



# Optional Accessories

## The Floor Care System-Floor Buffer (continued)

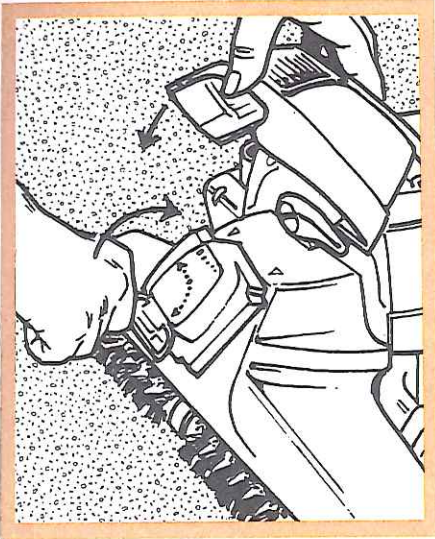

FLOOR BUFFER SET-UP (cont)

**6** To engage the drive belt and Buffer Brush, use the L-shaped handle to turn the Belt Lifter all the way to the right (clockwise) until the green arrows line up. Lower the Headlight Cap (21). ➤

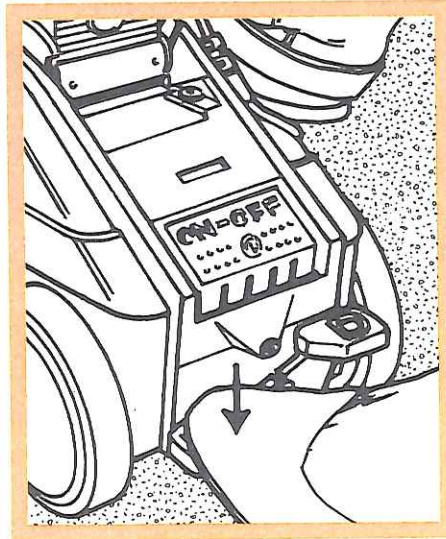

**7** DO NOT USE TechDrive® Power Assist with the Floor Buffer.  
Place TechDrive Power Assist in Neutral by stepping on the light gray “N” side (“N” for Neutral) of the TechDrive Power Assist N/D Pedal (11). ➤

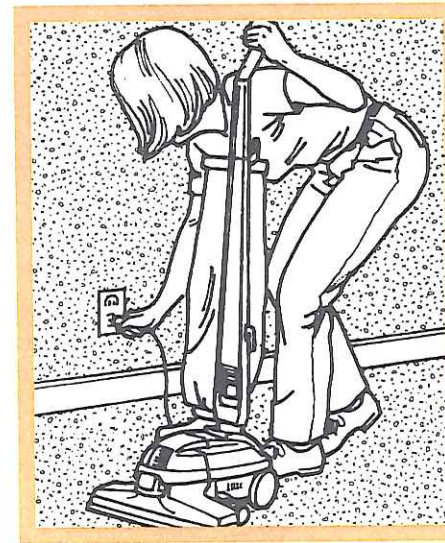

USING THE FLOOR BUFFER

**8** Because the unit moves forward when the Floor Buffer Brush touches the floor, make sure the Buffer Nozzle is on its highest setting. Press the Toe-Touch Control™ Bottom Pedal (9) all the way down to raise the Buffer Nozzle all the way up.

While holding onto the unit's handle, turn the Kirby® ON. ➤

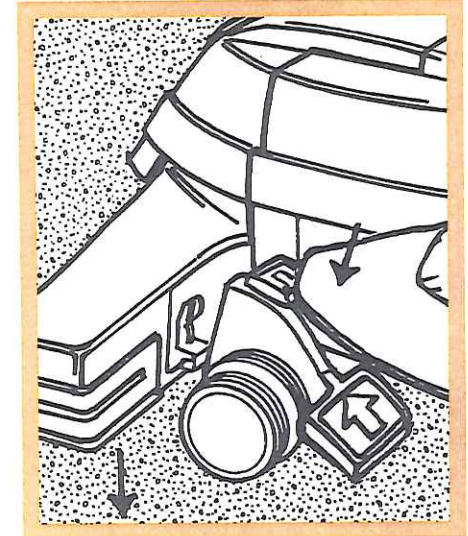

**9** Press the Toe-Touch Control Upper Pedal (8) to lower the brush one notch at a time. Lower the brush as far as the Toe-Touch Control will allow.

With the Buffer running, move the Kirby over the floor as though you were cleaning a carpet, using slow, steady strokes.

NOTE: The belt should not be stretched when stored for an extended period. Make sure the green arrows line up for storage (see page 9 for discussion of the Belt Lifter). □

**⚠ CAUTION:**

To avoid losing control of the Buffer when brush is on the floor surface, hold on to the handle before plugging the power cord into the wall outlet and before turning the power switch ON. To avoid possible damage to soft tiles or marking of waxed and finished non-carpeted floors, disengage the TechDrive.

# Optional Accessories

## The Floor Care System-Floor Buffer (continued)/The Floor Care System-Carpet Fluffer

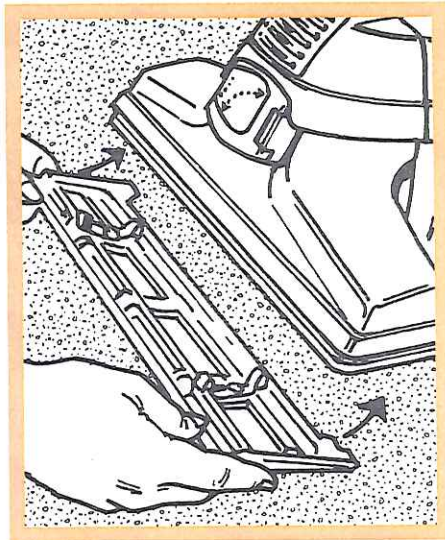

HARD FLOOR PAD

See page 14 for set-up and use of the Hard Floor Pad. □

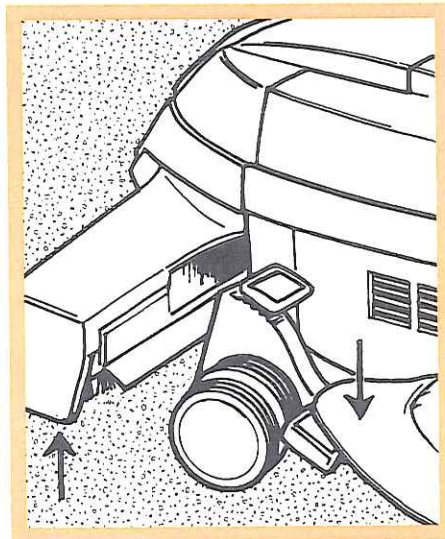

USING THE CARPET FLUFFER

Your G5™ Floor Buffer can also be used as a Carpet Fluffer to reset the nap on a matted-down carpet.

**1** Before fluffing the carpet, raise the nozzle all the way up by pushing the Toe-Touch Control™ Bottom Pedal ⑨ all the way down.

Place the cleaner on the carpet to be fluffed. ➤

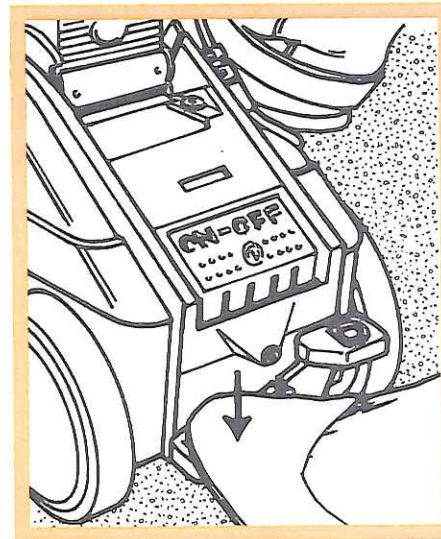

**2** Plug in the Power Cord. Disengage the TechDrive® Power Assist by pressing on the light gray "N" side of the TechDrive Power Assist N/D Pedal ⑪.

Holding onto the handle firmly, start the cleaner by pressing the ON switch.



**3** Lower the Carpet Fluffer Nozzle one notch at a time by pushing the Toe-Touch Control Upper Pedal ⑧. The instant the brush contacts the carpet, stop lowering the brush. ➤

# Optional Accessories

## The Turbo Accessory System™

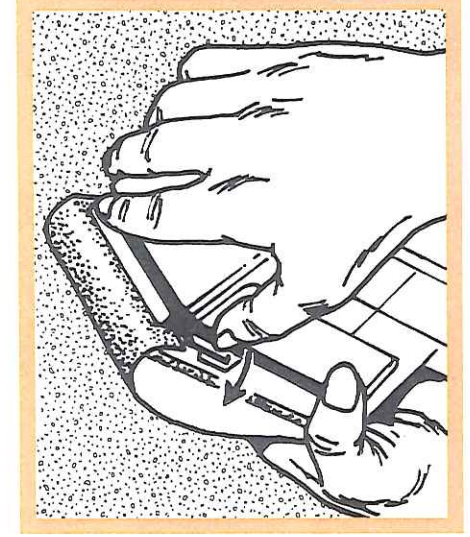
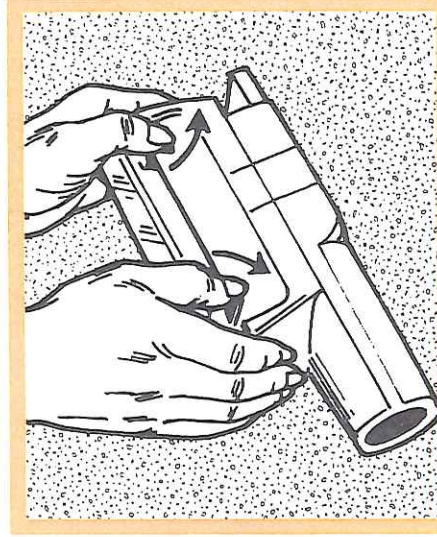
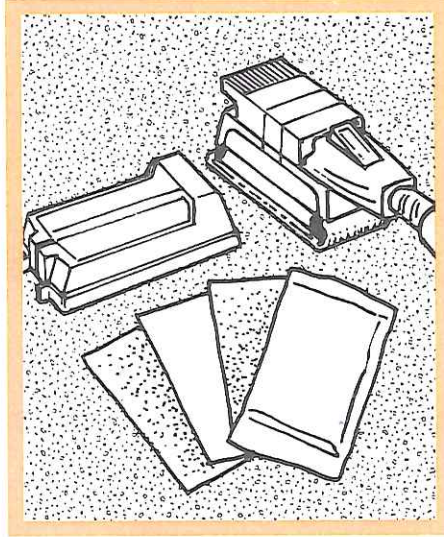
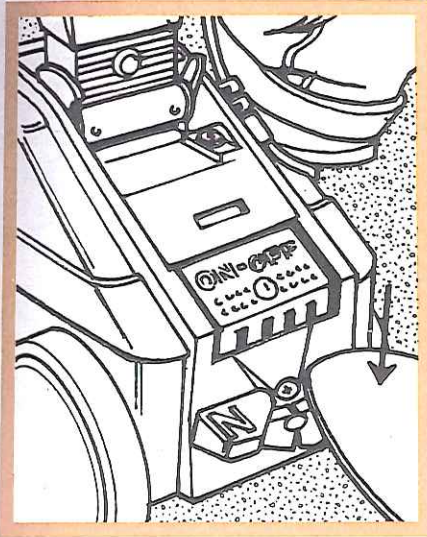

### TURBO ACCESSORY SET-UP

The Turbo Accessory System can be used for a wide variety of household jobs. It's a sander, a buffing unit, a scouring unit and a massage unit.

### TURBO-SANDING

**1** To set up the Turbo Accessory System as a sander, unsnap the Sander Dust Shroud at the rear of the tool and lift off. ➤

**4** Then engage TechDrive® by pressing down on the green "D" side of the "N/D" Pedal. You are now ready to fluff the carpet by pushing the cleaner back and forth over the carpet.

**NOTE:** • Lowering the brush too far on cable yarn type carpets may cause the carpet to fuzz. Do not fluff delicate carpets.

- The belt should not be stretched when stored for an extended period. Make sure the green arrows line up for storage (see page 9 for discussion of the Belt Lifter). □

**2** Rotate the clamp levers on the side of the Turbo Accessory upwards to open the clamps. ➤

**3** Select the correct grade of sandpaper needed for the job. Use fine paper for a smooth finish and coarse paper to clear rough surfaces or remove paint.

Slide the sheet into the front clamp and lock the clamp lever.

**NOTE:** Three grades of sandpaper come with the Sander. Each piece is a standard 1/3 sheet. ➤

**CAUTION:**

Be sure no metal objects, such as tacks, nails, etc., are sticking up from the surface. They can damage the sandpaper and the Turbo Accessory. They may also cause sparks, which could ignite dust. Replace the disposable bag after extended sanding because the dust is fine and will plug the bag pores.

# Optional Accessories

## The Turbo Accessory System™ (continued)

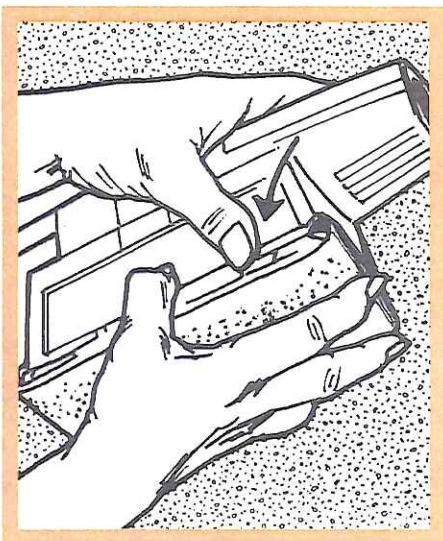

### TURBO-SANDING SET-UP (cont)

**4** Tightly wrap the paper around the bottom of the Turbo Accessory and tuck the end into the rear clamp. Lock the rear clamp. ➤

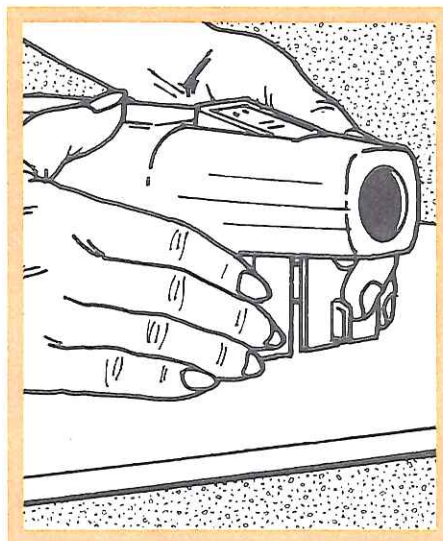

**5** With the Turbo Accessory on a level surface, wrap the Sander Dust Shroud around the Sander with the opening to the rear and snap it closed. ➤

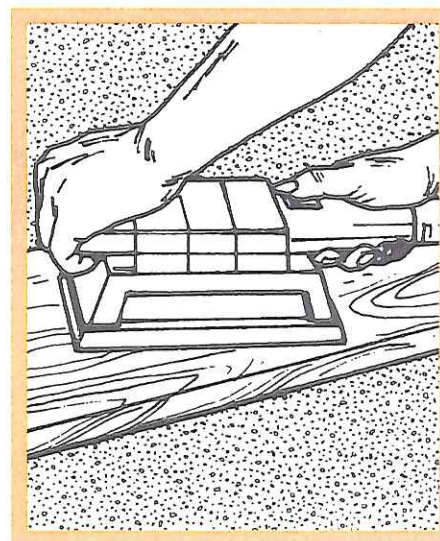

**6** Insert the Attachment Hose into the end of the Turbo Accessory.

Grip the Sander at the front and rear and turn the Kirby® ON. Then press the ON button on the top of the Sander.

While applying light pressure, move it over the surface slowly. Allow the Sander to do the work. Don't force it or lean heavily on it. The tool works best at high speed. □

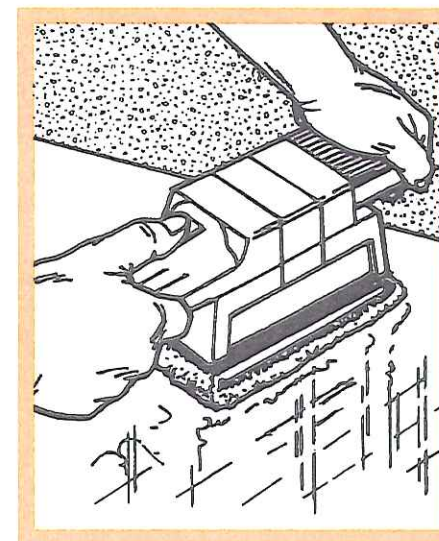

### TURBO POLISHING

Attach the synthetic lamb's wool pad using the same procedure as attaching sandpaper (see page 41). The Turbo Accessory now becomes a polisher. Use it for polishing hard waxed surfaces, such as table tops, paneling, large flat surfaces and cars.

The Dust Shroud is not used when polishing. □

# Optional Accessories

## The Turbo Accessory System™ (continued)/The Zippbrush™

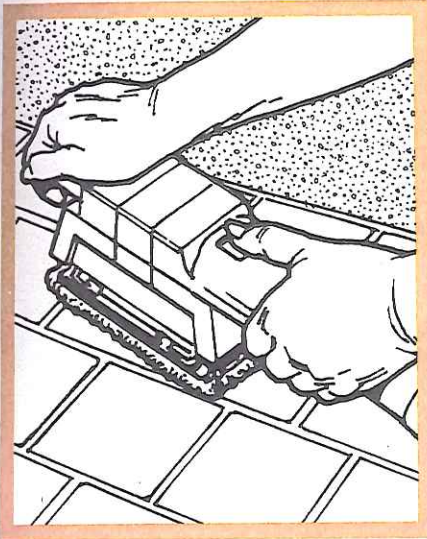

**TURBO SCOURING**

Attach the webbed nylon scouring pad using the same procedure as attaching sandpaper (see page 41). The Turbo Accessory now becomes a scouring tool. Use it for scouring hard surfaces such as ceramic tile, etc. (Do not use on painted surfaces.)

The Dust Shroud is not used when using the scouring pad. □



**ORBITAL MESSAGE UNIT**

The Turbo Accessory Massage Unit is intended for use where massage is desired or medically recommended.

To use as an Orbital Massage Unit, attach the soft vinyl pad to the Turbo Accessory using the same procedure as attaching sandpaper (see page 41).

The Suction Control Grip can be used to decrease the vibration of the Massager. Thus, a variable speed Massager. The Suction Control Grip also enables a person to massage their own back.

The Dust Shroud is not used when using the Turbo Accessory as a massage unit. □

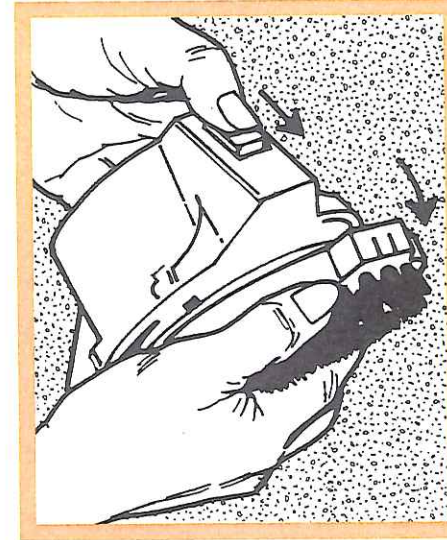

**USING THE ZIPPBRUSH™**

When attached to the Attachment Hose, the Zippbrush can be used for a wide variety of cleaning surfaces, including upholstery, carpeted steps and automotive interiors.

For optimum results, do not press down heavily on the Zippbrush. Allow the brush to rotate at maximum speed by gently moving it side to side on the surface being cleaned.



**CLEANING THE ZIPPBRUSH™**

**1** To clean the Zippbrush, press the button on the front of the brush to release the outer brush ring.

When pressing the release button, avoid placing pressure on the outer ring brush. ➤

For additional Zippbrush Caution see page 44.

**⚠ CAUTION:**

Do not use the Orbital Massager on swollen or inflamed areas, legs with varicose veins, areas where there are skin eruptions, unexplained calf pains or anesthetic skin areas unless first approved by your doctor. Children must be supervised when using the massager.

# Optional Accessories

## The Zippbrush™ (continued)

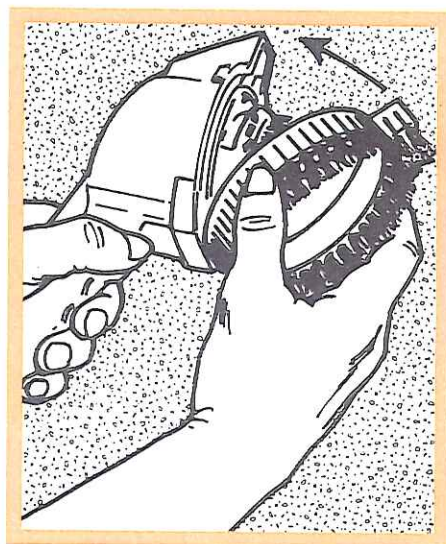

### CLEANING THE ZIPPBRUSH™ (cont)

**2** Lift the center Brush/Air Turbine out of the tool and remove any particles or lint from the brush and turbine. Also remove any particles left in the tool cavity. ➤

**3** Place the Brush/Air Turbine back in the tool and turn it until the tabs drop into the slots. Hook the tab on the rear of the ring brush into the small opening of the tool and snap it back into place. ◻



**CAUTION:**

While using the Zippbrush, do not insert fingers into the revolving brush area or push the release button while the brush is in motion. Keep brush flat against the surface being cleaned as the brush can throw particles outward. Do not use on delicate fabrics.

# Operating/Maintenance Tips

## PART FIVE

Your Kirby® G5™ is a highly sophisticated home maintenance system. As with most modern appliances, it requires a modest degree of routine maintenance to keep it operating efficiently. This section of the Owner's Manual presents tips on operating and maintaining your G5. In this section, we will discuss the following:

**Changing the Power Nozzle Belt**

**Adjusting the Brush Roll for Optimum Performance**

**Light Bulb Replacement**

**Miscellaneous Parts Replacement**

**Helpful Answers to Questions/Troubleshooting**

This section will provide the information you need to keep your G5 operating at peak efficiency.

# Operating/Maintenance Tips

## Changing The Power Nozzle Belt

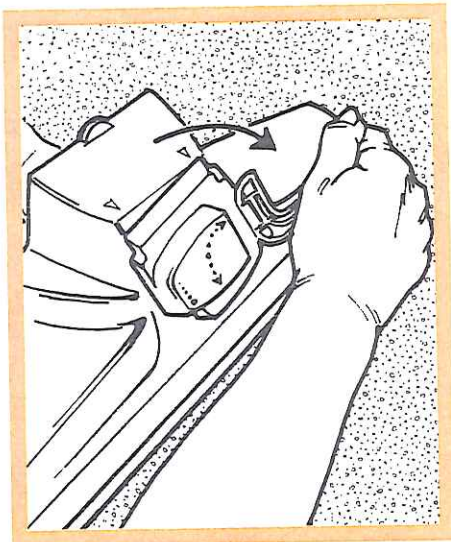

### CHANGING THE POWER NOZZLE BELT

After extended use, the Power Nozzle Belt on your G5™ may become stretched and worn causing the belt to slip. If this condition exists, simply replace the old belt with a new one.

NOTE: Use only approved Kirby® belts.

**1** To change the belt, remove the nozzle from the Kirby as on page 18. Then release the belt tension by using the L-shaped handle on the Belt Lifter (20) to turn it all the way to the right (clockwise) until the green arrows line up. ➤



**2** Unlock the Rug Plate (26) by unhooking the two latches on the rear of the nozzle. ➤

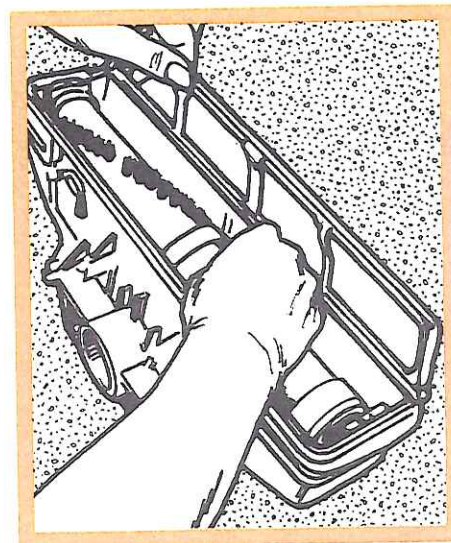

**3** Pull on the rear edge of the Rug Plate to remove from the nozzle. Lift out the Belt and Brush Roll. ➤

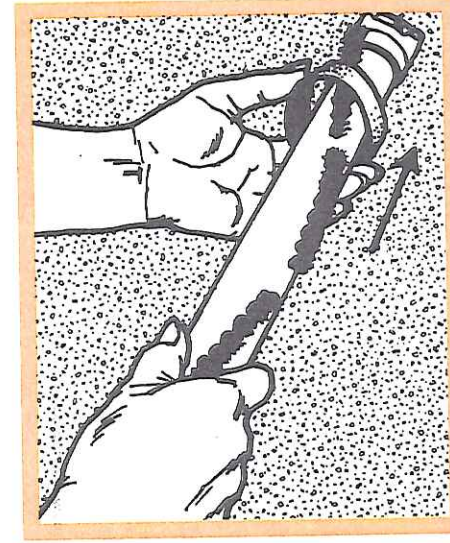

**4** Slide off the old belt and replace with a new one. ➤



# Operating/Maintenance Tips

## Changing The Power Nozzle Belt

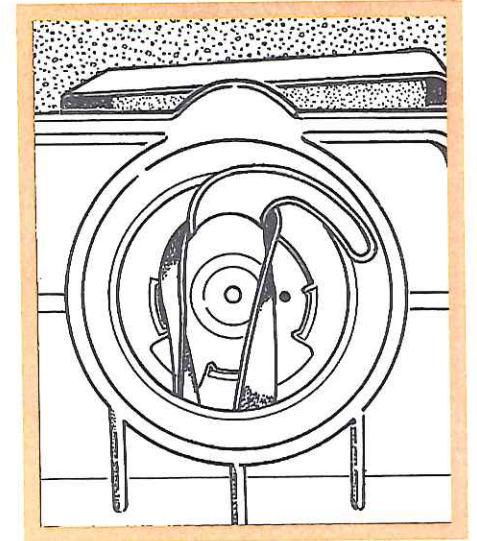
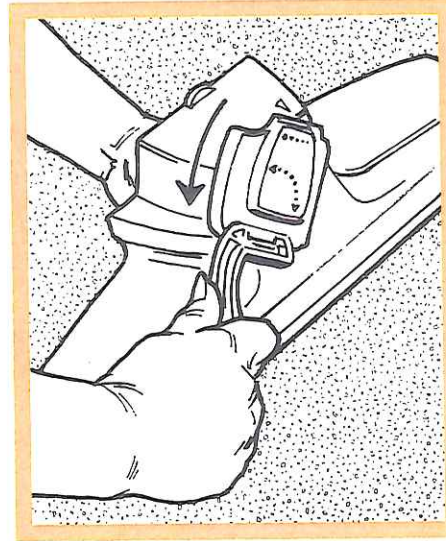
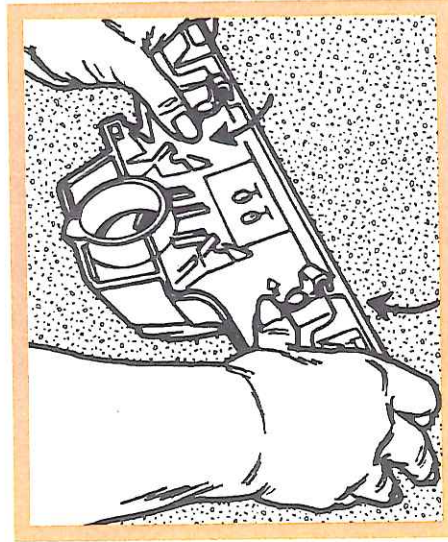

### CHANGING THE POWER NOZZLE BELT (cont)

**5** Make sure the Brush Roll Bristle Height Adjustment setting (Normal or Delicate) is the same as when the brush was removed. See page 48 for discussion of the Brush Roll Bristle Height Adjustment (Normal or Delicate setting). Place the belt and Brush Roll back into the nozzle. One of the plastic Brush Roll ends is larger than the other, thus the Brush Roll will only fit in the nozzle one way.

Then center the belt on the Brush. ➤

**6** Replace the Rug Plate **26** by placing it on the front of the bumper first and then pulling it over the bumper on rear of Power Nozzle **25**. Secure the Rug Plate using the two latches that hold it in place. ➤

**7** Using the L-shaped handle on the Belt Lifter **20**, turn it to the left (counter-clockwise) until the red arrows line up. This will stretch the belt in preparation for returning the nozzle to the Kirby®. ➤

**8** The belt will be stretched to the top of the nozzle as shown above. Now you are ready to re-attach the Power Nozzle and re-engage the belt (see page 9 for details). ◻

# Operating/Maintenance Tips

## Brush Roll Bristle Height Adjustment

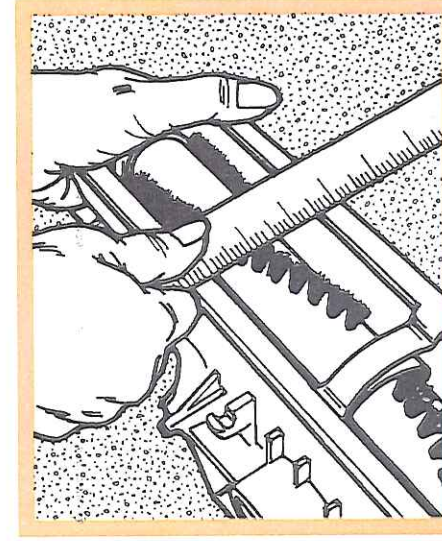
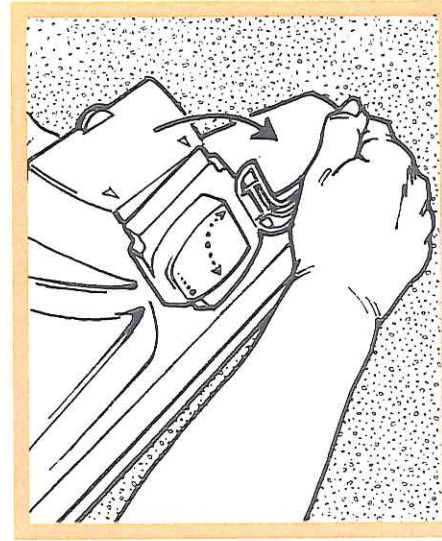
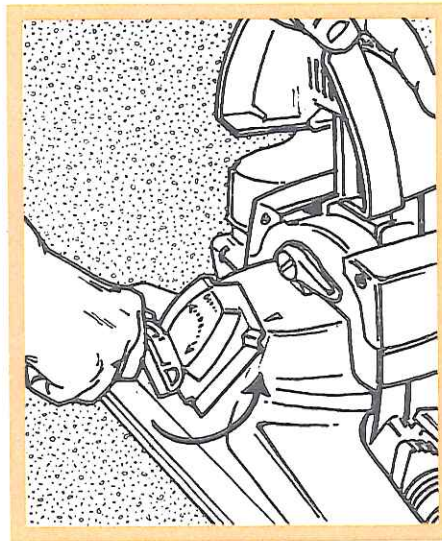
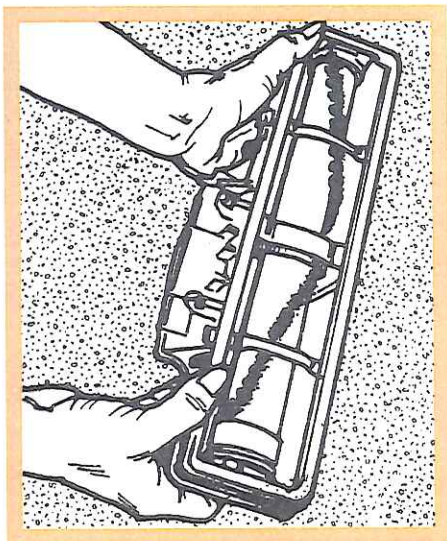

### ADJUSTING THE BRUSH ROLL HEIGHT

As shipped from the factory, Brush Roll height is set at the Normal setting. At this setting, the bristles of the Brush Roll are extended to their maximum position. The resulting aggressive Brush Roll agitation results in maximum cleanability.

When using your Kirby® on delicate carpets (such as Berber or delicate Oriental rugs), it may be advisable to adjust the Brush Roll height to the Delicate setting. At this setting, the bristles of the Brush Roll do not extend as far. The result is less aggressive Brush Roll agitation, less wear on delicate carpet fibers and slightly decreased cleaning efficiency.

To change the Brush Roll Bristle Height Adjustment (Normal or Delicate setting), do the following: ➤

**1** Remove the Power Nozzle (25) from the Kirby as on page 18. ➤

**2** Release the belt tension by using the L-shaped handle on the Belt Lifter (20) to turn it all the way to the right (clockwise) until the green arrows line up.

Unlock the two latches on the rear of the Power Nozzle to remove the Rug Plate (26).

Then lift the brush out of the nozzle. ➤

**3** Rotate the plastic Brush Roll ends to the Normal or Delicate settings as desired. The plastic Brush Roll ends are coded to represent the Normal and Delicate settings. Two notches indicate the Normal setting and one notch indicates the Delicate setting.

When viewed from the top, rotate the plastic Brush Roll ends to the side with two notches visible for the Normal setting or one notch visible for the Delicate setting. Make sure both plastic Brush Roll ends are set to the same number of notches. ➤

# Operating/Maintenance Tips

## Brush Roll Bristle Height Adjustment/Light Bulb Replacement

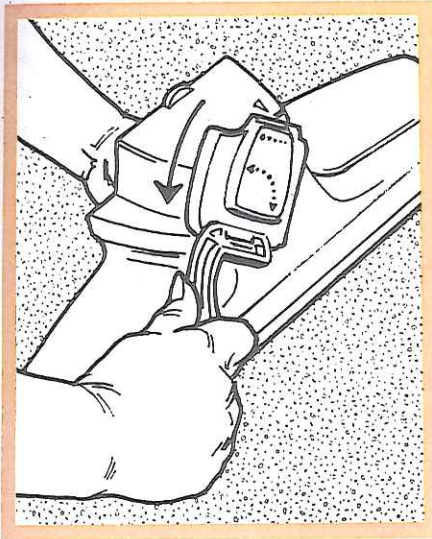

### ADJUSTING THE BRUSH ROLL HEIGHT (cont)

**4** Place the brush back into the nozzle making sure both plastic Brush Roll ends are set to the same number of notches (Normal or Delicate).

Replace the Rug Plate (26) by placing it on the front of the bumper first and then pulling it over the bumper on rear of Power Nozzle (25). Secure the Rug Plate using the two latches that hold it in place.

Using the L-shaped handle, hook the belt onto the Belt Lifter (20) and turn the Belt Lifter to the left (counter-clockwise) until the red arrows line up. This will stretch the belt in preparation for returning the nozzle to the Kirby® (See page 47 for additional details.) □

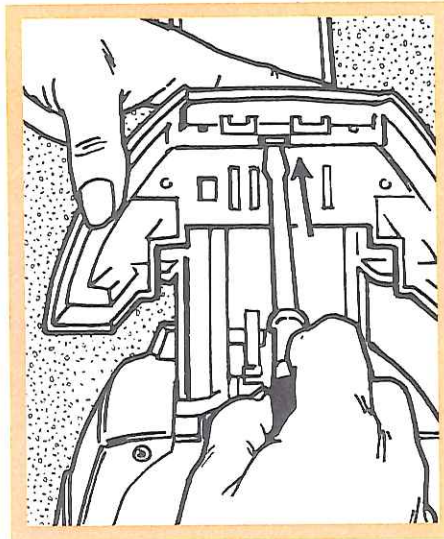

### LIGHT BULB REPLACEMENT

If the light bulb in your Headlight Assembly burns out, you may wish to contact your authorized Kirby Distributor. If you prefer to install a new light bulb yourself, use the following procedure:

**1** Turn off and unplug your Kirby. Raise the Headlight Hood (21). On the underside of the hood, locate the horizontal slot in the center just above the arrow. Insert a flat screwdriver in the slot and push until the plastic lens loosens. Pop the lens off. ➤



**2** Lower the Headlight Hood. With your forefinger and thumb, gently wiggle the light bulb until it loosens. Gently pull it out of the socket. Gently push a new bulb into the opening. ➤



**3** Before you re-attach the lens, look at the two tabs on the rear of the lens. Both should face up. Insert the lens into the lens opening and gently fit into place. □

# Operating/Maintenance Tips

## Miscellaneous Parts Replacement

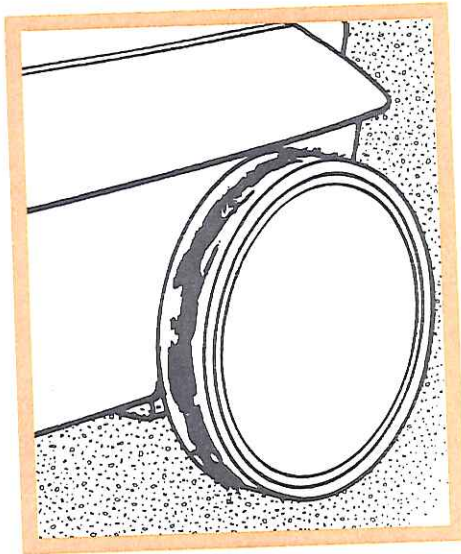

### WHEEL WEAR/ REPLACEMENT

Kirby® G5™ wheels are made with a pliable tread that is designed to prevent carpet wear and prevent damage to non-carpeted floors. After extended periods of use, the tread on the wheels will wear out and the wheels will need to be replaced.

Check wheel tread occasionally to determine if the wheels need to be replaced. The tread material is lighter in color than the plastic wheel itself. If any of the darker plastic wheel is showing through the tread, the wheels need to be replaced. The wheels are not user-replaceable. Contact your nearest authorized Kirby Service Center for prompt, courteous wheel replacement. □

### CORD REPLACEMENT

If the electrical cord connecting the Kirby to the outlet becomes cut or frayed over time, **DO NOT USE THE UNIT.** Contact your authorized Kirby Service Center immediately for replacement.

Avoid damage to your cord by being careful not to run over it with your G5. Also, unplug your unit by grasping the plug at the end of the cord rather than pulling on the cord itself. □

# Operating/Maintenance Tips

## Question and Answers/Troubleshooting

### **Q** WHAT IS A DOUBLE-INSULATED MACHINE? (Servicing of double-insulated appliances)

**A** In a double-insulated appliance, two systems of insulation are provided instead of grounding. No grounding means is necessary on a double-insulated appliance, nor should a means for grounding be added to the appliance. A double-insulated appliance is marked with the words "DOUBLE-INSULATED" (U.S.A. and Canada). The symbol  (square within a square) may also be marked on the appliance.

Servicing a double-insulated appliance requires extreme care and knowledge of the system and should be done only by qualified service personnel.

Replacement parts for this double-insulated Kirby® G5™ model must be genuine Kirby parts for maintenance of safety and protection of warranty.

### **Q** WHAT SHOULD I DO IF THE MOTOR DOES NOT RUN WHEN I TURN THE KIRBY ON?

**A** Many service calls are unnecessary. Checking a few simple things can save a lot of cost, time and trouble. Whenever your Kirby does not perform properly, make these checks first before calling authorized service personnel.

#### IF THE MOTOR DOES NOT RUN WHEN THE MOTOR ON-OFF SWITCH IS PUSHED:

1. Make sure the Power Cord is plugged into an outlet and that the outlet has power. (Check for a blown

fuse, tripped circuit breaker or power company trouble.)

2. Make sure the cord plug is fully inserted into the Kirby.
3. Look for breaks in the Power Cord insulation. If the cord is damaged, get a new one. **DO NOT ATTEMPT TO REPAIR IT.** Use only a genuine Kirby Power Cord. Do not use standard extension cords.
4. Make sure that an attachment or accessory is properly mounted on the front of the Power Plant. The Kirby will not run without the Power Nozzle (25), Hose Coupling, Air Intake Guard (19) or Accessory Brush Nozzle in place.
5. The Kirby will not operate without either a Filtration Bag Assembly/ Mini Em-Tor® (6), Attachment Hose or Carpet Shampoo Tank properly installed on the Air Exhaust Port (19).
6. The Filtration Bag Assembly/Mini Em-Tor, Attachment Hose or Carpet Shampoo Tank must "click" firmly into place for the Kirby to operate. If the fitting is too tight and you have difficulty installing the above, apply a small drop of water to the gasket to reduce friction and ease installation.

### **Q** WHAT SHOULD I DO IF THE KIRBY® DOES NOT PICK UP LINT OR DIRT ON THE CARPET?

- A**
1. Check to see if the Brush Roll is turning, when the Kirby is running.
  2. If the Brush Roll is not turning freely, the belt is slipping, broken or not on the motor pulley (23).

3. If the belt is not on the pulley (23), remove the nozzle and follow the instructions on pages 9 and 47. See page 48 for bristle extension.
4. If the belt is in good condition and the brush is running, check for bristle wear and replace Brush Roll, if necessary.  
  
To check for wear, turn the Power Nozzle (25) over and place a ruler against the Metal Rug Plate (26). If the bristles are below or just touching the ruler, the Brush Roll should be adjusted. See page 48 for details.
5. Make sure that the nozzle height is adjusted to place the brush in contact with the carpet. Use the Toe-Touch Control™ to adjust as appropriate. See page 6.
6. Check the bag to see if it is full.
7. Check the fill tube (5) for clogging.
8. Make sure the nozzle is not set too low. Raise the Toe-Touch Control one or two notches.

### **Q** I SMELL BURNING RUBBER WHEN I USE MY KIRBY® WHAT SHOULD I DO?

- A**
1. Check to see if the Brush Roll is turning when the Kirby is running. If not, then the Brush Roll may be stalled due to threads around the ends. Remove Brush Roll and make sure it rotates freely at both ends. See page 46.
  2. The belt may not be fully engaged (or disengaged). Make sure the green arrows or red arrows on the Belt Lifter (20) match up fully.

3. The nozzle may be adjusted too close to the carpet. Start by pressing the Toe-Touch Control Bottom Pedal (9) all the way down, raising the front of your Kirby all the way up. Then, with your Kirby ON, press the Toe-Touch Control Upper Pedal (8), one notch at a time, until you hear a change in the tone of the motor. This means your Kirby has sealed to the carpet. Press the Toe-Touch Control Upper Pedal one more time and your power nozzle will be at the proper operating height.
4. If a slipping belt has deposited a black residue on the Motor Shaft (23), remove it gently using steel wool or sandpaper and replace the belt.

### **Q** HOW DO I VACUUM MY MATTRESS?

- A**
1. Remove all bedding, including mattress cover, from the mattress.  
  
2. Convert your upright G5 to a Portable Cleaner. See "Portable Cleaning" on page 14.
  3. Place Portable Cleaner on the mattress.
  4. Disengage TechDrive® by pressing the light gray "N" side (marked "N" for Neutral) of the N/D Pedal (11).
  5. Plug in your Kirby and turn it ON.  
  
NOTE: On delicate mattress surfaces, you may want to convert to straight suction by disengaging the Brush Roll. See page 15. (If your mattress has tufted buttons on the surface, avoid contact with the revolving Brush Roll.)
  6. Lower the Power Nozzle by pressing the Toe-Touch Control Upper

# Operating/Maintenance Tips

## Question and Answers/Troubleshooting

Pedal (8) until it is all the way down.

7. With your hand on the Portable Handle (15), engage TechDrive® by pressing the green “D” side (marked “D” for Drive) of the N/D Pedal (12).

8. Begin vacuuming.

### Q HOW DO I VACUUM MY CARPETED STAIRS?

A There are several different ways. You can use:

- the Portable Cleaner
- the Zippbrush™
- or the Upholstery Nozzle

To vacuum the carpeted stairs in the portable cleaning mode (with the Power Nozzle (25) attached):

1. Convert your upright G5™ to a Portable Cleaner. See “Portable Cleaning” on page 14.
2. Disengage TechDrive by pressing the light gray “N” side (marked “N” for Neutral) of the N/D Pedal (11).
3. Plug in your Kirby®.
4. Place Portable Cleaner on a carpeted step.
5. Turn your Kirby ON.
6. Starting with the Power Nozzle (25) on the highest setting, lower the Power Nozzle by pressing the Toe-Touch Control™ Upper Pedal (8) one notch at a time until you hear a change in the motor’s tone. Now, drop it one more notch.
7. Grip the handle with one hand and begin vacuuming. If necessary, hold your free hand under the rear of the power plant for balance.

**IMPORTANT:** Always exercise caution when vacuuming stairways.

### Q HOW DO I VACUUM MY UPHOLSTERED FURNITURE?

- A
1. Convert to a canister. See page 18. (Do not use Power Nozzle (25) on furniture.)
  2. Use the Attachment Hose with or without the following attachments:
    - the Upholstery Nozzle.
    - the Crevice Tool with the brush removed. (Use in between seat cushions and in crevices.)
    - the optional Zippbrush.

The optional Zippbrush uses rotating brushes to agitate fibers and remove imbedded dirt and pet hair from the fabric. When using the Zippbrush, move it slowly from side to side across surface. Do not apply heavy pressure as it will slow the brush action. (If the brush becomes jammed and stops turning, simply rotate the inner rotating brush clockwise to free it up and let go. It should then resume turning.)

To clean hard-to-reach upholstery buttons, use narrow tip of the Zippbrush, located on the side opposite the hose, to work the dirt loose. (For additional information on the use and maintenance of the optional Zippbrush, see the Zippbrush section on page 43).

### Q HOW DO I CLEAN MY WALLS AND CEILING?

- A
1. Convert to a canister. See page 18.

2. Attach one or two Extension Tubes to the Attachment Hose by inserting the hose into the Extension Tube opening and twisting to lock in place.
3. Attach the Suction Control Grip onto the end of the Extension Tube.
4. Attach the Wall & Ceiling Brush to the end of the Suction Control Grip. The Suction Control Grip not only allows you to regulate airflow, it also allows you to adjust the Wall & Ceiling Brush to the proper angles for mantles, window ledges, walls and ceilings.

### Q HOW DO I CLEAN MY CAR?

A Your G5 comes equipped with a range of tools to help you clean your car. In addition, you may also use the optional Zippbrush for vacuuming automobile upholstery, carpeting, floor mats and trunks. (See Zippbrush section on page 43 for Zippbrush use and maintenance information.)

1. Convert to a canister. See page 18.
2. You can use the end of the Attachment Hose for straight suction or attach any one of a variety of tools.
3. We suggest using the Upholstery Nozzle (or optional Zippbrush) to clean the seats, areas under the seats and the trunk.
4. Use the Crevice Tool (with or without the small Crevice Tool brush end) for small, hard-to-reach areas, such as the area between the windshield and dash and the area between the seats.
5. Use the Duster Brush to clean the instrument panel.
6. Use the Massage Cup to pick up

particles on floor mats and carpeting

### Q HOW DO I CLEAN OTHER HOME FURNISHINGS?

A Books and Bookcases:

1. Convert to a canister. See page 18.
2. Attach the Duster Brush to the end of the Attachment Hose and “dust” the books and bookcase.
3. Other options include using an Extension Tube with the Duster Brush or the Wall & Ceiling Brush to dust the bookcase top.

Lampshades and Pictures:

1. Convert to a canister. See page 18.
2. Attach the Duster Brush to the Suction Control Grip. Then connect the grip to the Attachment Hose. Test the airflow by regulating the Suction Control Valve on the Suction Control Grip before you dust your lampshades. Dust glass-covered artwork and picture frames.

Stereos and Computers:

1. Convert to a canister. See page 18.
2. Attach the Duster Brush to the Suction Control Grip. Then connect the grip to the Attachment Hose. Test the airflow by regulating the Suction Control Valve on the Suction Control Grip before you dust your home electronics.
3. Connect the Inflator/Deflator tool to the end of the Attachment Hose to dust between the keys on a computer keyboard, faceplates on electronic gear and other hard-to-reach small spaces.

# Operating/Maintenance Tips

## Questions and Answers/Troubleshooting

Wicker Furniture and Baskets:

1. Convert to a canister. See page 18.
2. Attach the Duster Brush to the end of the Attachment Hose. Your Duster Brush works well between cracks and crevices on wicker and other irregular surfaces.

Drapes and Blinds:

1. Convert to a canister. See page 18.
2. For drapes, attach one or two Extension Tubes to the Attachment Hose. Connect the Suction Control Grip to the Extension Tube and then connect the Upholstery Nozzle (with the faceplate attached). Test the airflow by regulating the Suction Control Valve on the Suction Control Grip before you dust your drapes and blinds.

The Suction Control Valve on the Suction Control Grip regulates airflow and prevents you from pulling the drapes off the curtain rods.

For blinds, follow a similar procedure using the Duster Brush instead of the Upholstery Nozzle. If using the Suction Control Grip, make sure to completely close the Suction Control Valve to maintain maximum airflow.

open area, put it in Neutral and turn it ON. Let it run in Neutral for five minutes with the clean bag installed.

Make sure the Power Nozzle (25) is raised to its highest level by pressing the Toe-Touch Control™ Bottom Pedal (9) all the way down. Disengage the Brush Roll by flipping out the L-shaped handle on the Belt Lifter (20). Use it to turn the Belt Lifter all the way to the left (counter-clockwise).

1. You may also purchase Odorific® II, an odorizer that leaves your room smelling clean and fresh. Place a few drops on a cottonball and toss it in the Outer Permanent Bag. Call your Distributor or the Kirby Supply Line at 1-800-437-7170. For a list of other fine Kirby products, see page 54 and 55.

### **Q** WHAT SHOULD I DO IF MY BAG SMELLS?

**A** Change it. Replace the bag when the dirt reaches the fill line. Do not overfill. Once the bag is changed, roll your Kirby® to an

# Kirby® Cleaning Products

## Other Fine Kirby Products and Supplies

### **CARPET SHAMPOO**

Highly effective carpet shampoo. Contains Kirby Guard anti-soiling agent and fabric brightener to keep carpets and upholstery looking like new. Has a pH of 9 for color-fast carpets. Available in 12 oz., 32 oz., 1 gallon and 5 gallons.

### **SHAMPOO PRE-TREATMENT**

Specially formulated for pre-treating oil and grease-stained areas prior to shampooing— 12 oz. spray bottle.

### **SCUTTLE®**

Versatile cleaner for a wide variety of hard surfaces, including countertops, appliances, tile and more. Ideal for general-purpose cleaning all around the house. Available in 24 oz. container.

### **SPOT REMOVER**

Efficient stain remover designed for protein-based food stains. Simply “spot,” then “blot”—it’s that easy! 12 oz.

### **HOME FRESHENER**

Fast-working powdered room freshener. Sprinkle on carpets and vacuum in seconds. Available in four delightful scents that last all day.

### **ODORIFIC® II**

All purpose deodorizer eliminates household odors. One drop lasts up to 24 hours!

### **MIRACLE WAX**

Specially designed to give you maximum performance with your Kirby Floor Buffer. Protects no-wax vinyl and finished wood floors.

### **HARD SURFACE CLEANER**

Cleans and brightens countertops, appliances, yard furniture, tile, stainless steel, painted wood and porcelain. 24 oz.



# Kirby® Cleaning Products

Other Fine Kirby Products and Supplies

## **DISPOSABLE FILTER BAGS**

Get the most out of your G5™ with genuine Kirby disposable filter bags. Available in handy three and nine packs.

## **REPLACEMENT BELTS**

Maintain peak efficiency with G5 replacement belts from Kirby. Available in handy three packs for use with the Power Nozzle, Carpet Shampoo Nozzle and Floor Buffer Nozzle.

## **SPLIT SECOND®**

This cordless portable hand vacuum can be used where cord-type cleaners cannot reach. Comes complete with handy re-charging unit so it's always ready for use.

## **SPLIT SECOND® II**

The twelve-volt automotive version of the popular Split Second portable hand vacuum plugs into a standard cigarette lighter. Perfect for cars, boats, campers and recreational vehicles.

# Index

## A

About this Manual.....	4
Accessories.....	29
Accessory Lock.....	18
Air Intake Guard.....	22
Attaching Bar.....	18
Attachments.....	19
Attachment Hose.....	18
Crevice Tool.....	20
Duster Brush.....	20
Extension Tubes.....	19
Inflator/Deflator.....	23
Massage Cup.....	21
Suction Control Grip.....	21
Upholstery Nozzle.....	20
Wall & Ceiling Brush.....	20

## B

### Bag

Assembly-removal.....	9
Bag Release Button.....	14
Bag Support Strap.....	9
Changing Bags.....	8
Disposable Filter Bags.....	8
Outer Permanent Bag.....	9
Top Adapter.....	8

### Belts

Changing Belts.....	46
Replacement Belts.....	55

### Belt Lifter

.....	9
-------	---

### Blower

set-up.....	21
using.....	23

### Brush Roll

adjusting for	
optimum performance.....	48
height adjustment.....	48

## C

Canister Cleaner.....	17
-----------------------	----

Carpet Fluffer.....	40
Carpet Shampoo System.....	30
Belt Lifter.....	30
cleaning.....	33
replacing the belt.....	35
set-up.....	30
Suds Control Valve.....	32
tray.....	30
using.....	32
Carrying your G5™.....	6
Cleaning products.....	54
Crevice Tool.....	20

## D

Disposable Filter Bags.....	8,55
Duster Brush.....	20

## E

Extension Tubes.....	19
----------------------	----

## F

Floor Buffer.....	37
Belt.....	37
set-up.....	37
using.....	39

## G

Getting Started.....	5
----------------------	---

## H

Handle	
Attaching Portable Handle.....	14
Handle Tilt Latch.....	6
Handle Release Button.....	14
removing Upright Handle.....	14
Hard Floor Pad.....	14

## I

Inflator/Deflator Tool.....	23
-----------------------------	----

## K

Kirby Carpet Shampoo.....	31,54
---------------------------	-------

## M

Maintenance tips.....	45
Massage Cup.....	21
Mattress cleaning.....	15
Mini Em-Tor®-emptying.....	9
Moving your machine.....	6

## O

Operating Tips.....	45
Optional Accessories.....	29
Owner's Manual-using.....	4

## P

Portable Cleaner.....	14
Portable Handle.....	14
Portable Shampooer	
set-up.....	26
using.....	27
Portable Sprayer	
adjusting spray.....	25
cleaning.....	25
Dip Tube.....	25
Jar.....	24,25
reassemble.....	26
set-up.....	24
spray opening.....	26
using.....	24

### Power Nozzle

changing the belt.....	46
disengaging Brush Roll.....	13
height setting.....	7
lowering.....	7
raising.....	7
removal.....	18
Rug Plate.....	46
Brush Roll.....	46

### Power Switch.....

.....	12
-------	----

## Q

Questions & Answers.....	51
--------------------------	----

## R

Replacement Belts.....	55
------------------------	----

## S

Safety Instructions.....	2
Straight Suction Cleaning.....	13
Suction Control Grip.....	21
Surface Nozzle.....	19

## T

Table of Contents.....	3
TechDrive®	
description.....	7
ON/OFF Pedal.....	7
Turning off.....	8
Turning on.....	7
Tilt Latch.....	6
Toe-Touch Control™.....	6
Turbo Accessory System™.....	41
clamp levers.....	41
Dust Shroud.....	41
massage.....	43
polishing.....	42
rear clamp.....	42
sanding.....	41
scouring.....	43
set-up.....	41

## U

Upholstery Nozzle.....	20
Upright Cleaner.....	12
Upright Handle-removing.....	14

## Z

Zippbrush™	
Turbine.....	44
cleaning.....	43
Outer Brush Ring.....	43
using.....	43

The following information need only apply when changing plugs on G5 (TM)'s that are used in the U.K., Australia, South Africa and New Zealand.

### IMPORTANT

The wires in this mains lead are coloured in accordance with the following code:

Blue.....	Neutral	Brown.....	Live
-----------	---------	------------	------

As the colours of the wires in the mains lead of this appliance may not correspond with the coloured marking identifying the terminals in your plug, proceed as follows:  
**WARNING:** DO NOT connect either wire to the terminal marked "E" or with the earth  $\equiv$  symbol. No wire is connected to this terminal. The wire which is coloured Blue must be connected to the terminal which is marked with the letter N or coloured black. The wire which is coloured Brown must be connected to the terminal which is marked with the letter L or coloured red. If a U.K.: 13A (BS 1363) plug is used, fit a 5A fuse. For any other type plug, protect with a 5A fuse or fuse wire in the adaptor or distribution board. If the plug does not fit the sockets in the user's house, it should be cut off and safely disposed of and the correct plug fitted. The G5 is approved by the British Electrotechnical Approvals Board (BEAB).

**Warning:** There is a shock hazard if a plug that has been cut from the supply cord is inserted in a 13A socket outlet.

Any replacement fuse in the plug must be an ASTA approved BS1362 5A fuse in the U.K.

**Warning:** If the fuse cover is removable, never use the plug with the fuse cover removed.

If supply cord is damaged and needs to be replaced, the replacement part number is: 954097-Australia/New Zealand; 980697-Continental Europe; 946897-South Africa; 953897-United Kingdom; 192097-U.S.A.; 198697-U.S.A. Commercial Cord Set.

# CE DECLARATION OF CONFORMITY

We declare under our sole responsibility that this product is in conformity with the following standards or standardized documents.

EN 55 014, EN 60 555, EN 60 335-1 and EN 60 335-2-2

in accordance with the regulations 89/336/EEC, 73/23/EEC, 93/68/EEC

CE 95



Richard A. Baumgartner  
KIRBY CO.  
Cleveland, Oh 44102  
U.S.A.



A. E. Koch  
ATS Ltd.  
Ch-6314 Unterägeri

Made under one or more of the following patents and design registrations, other patents and design registrations pending.

## United States

4514199  
4573235  
4733532  
4877432  
4905343  
4947512  
5007133  
5014387  
5047597  
5057131  
5064455  
5086536  
5092915  
5115537  
5187832  
5285550  
5308288  
5335740

## Canada

1164610  
1271006  
RD. ENR. - 66977  
**Australia**  
582715  
610422  
616833  
633948  
640711  
661597  
**Austria**  
0233933  
**Belguim**  
0233933  
**Benelux**  
0233933  
**Denmark**  
Dansk Mønsterregistering  
Nr. Mr 0679 1991

## France

0233933  
**Germany**  
Geschütztes Muster  
M9002507.5  
P3650439.4-08  
68916013.5  
**Italy**  
0233933  
**Japan**  
1997813  
2011083  
**Luxembourg**  
0233933  
**Mexico**  
175870  
**Netherlands**  
0233933  
**New Zealand**  
236192

## Norway

169940  
175085

## South Africa

S.A. Patent No. 90/5400  
S.A. Patent No. 93/5427

## South Korea

66480  
75716

081950

## Sweden

0233933

## Switzerland

0233933

## United Kingdom

U.K. Patent 0233933  
U.K. Patent 03990031  
U.K. Patent 2229651  
U.K. Reg. 2005900

# Notes



# Notes

